



strong.

# Lathe Chucks Independent Chucks

2013/2014

[www.roehm.biz](http://www.roehm.biz)

**RÖHM**  
driven by technology

## LATHE CHUCKS - INDEPENDENT CHUCKS

### Key bar chucks with quick-acting jaw change system

DURO-T	3004
Jaws DURO-T	3008
Accessories DURO-T	3011
DURO-TA - sealed design	3014
Jaws DURO-TA	3015
Accessories DURO-TA	3016

**NEW**

### Geared scroll chucks in steel design

Basic - ZS-ZSU	3021
----------------	------

### Geared scroll chucks in cast iron design

Economy - ZG-ZGU	3024
Jaws ZS-ZSU / ZG-ZGU	3027
Accessories ZS-ZSU / ZG-ZGU	3030

### Two-jaw lathe chucks

Economy - ZGF	3032
Jaws ZGF	3033
Accessories ZGF	3034

### Lathe and grinding chucks

Precision - ZG Hi-Tru	3035
Jaws ZG Hi-Tru	3036
Accessories ZG Hi-Tru	3039

### Geared scroll chucks with independently adjustable jaws

Flex - EG-ES	3046
Jaws EG-ES	3047
Accessories EG-ES	3048

### Lever scroll chucks

KRF	3052
KRF - on base plate	3053
Jaws KRF	3054
Accessories KRF	3054

### Jaw cutting attachment

BAV	3055
-----	------

### Adapter plates

Adapter plates	3056
----------------	------

### Steel independent chucks

USE-USU	3059
Jaws USE-USU	3061
Accessories USE-USU	3062

### Cast iron independent chucks

UGE-UGU	3065
Jaws UGE-UGU	3067
Accessories UGE-UGU	3068



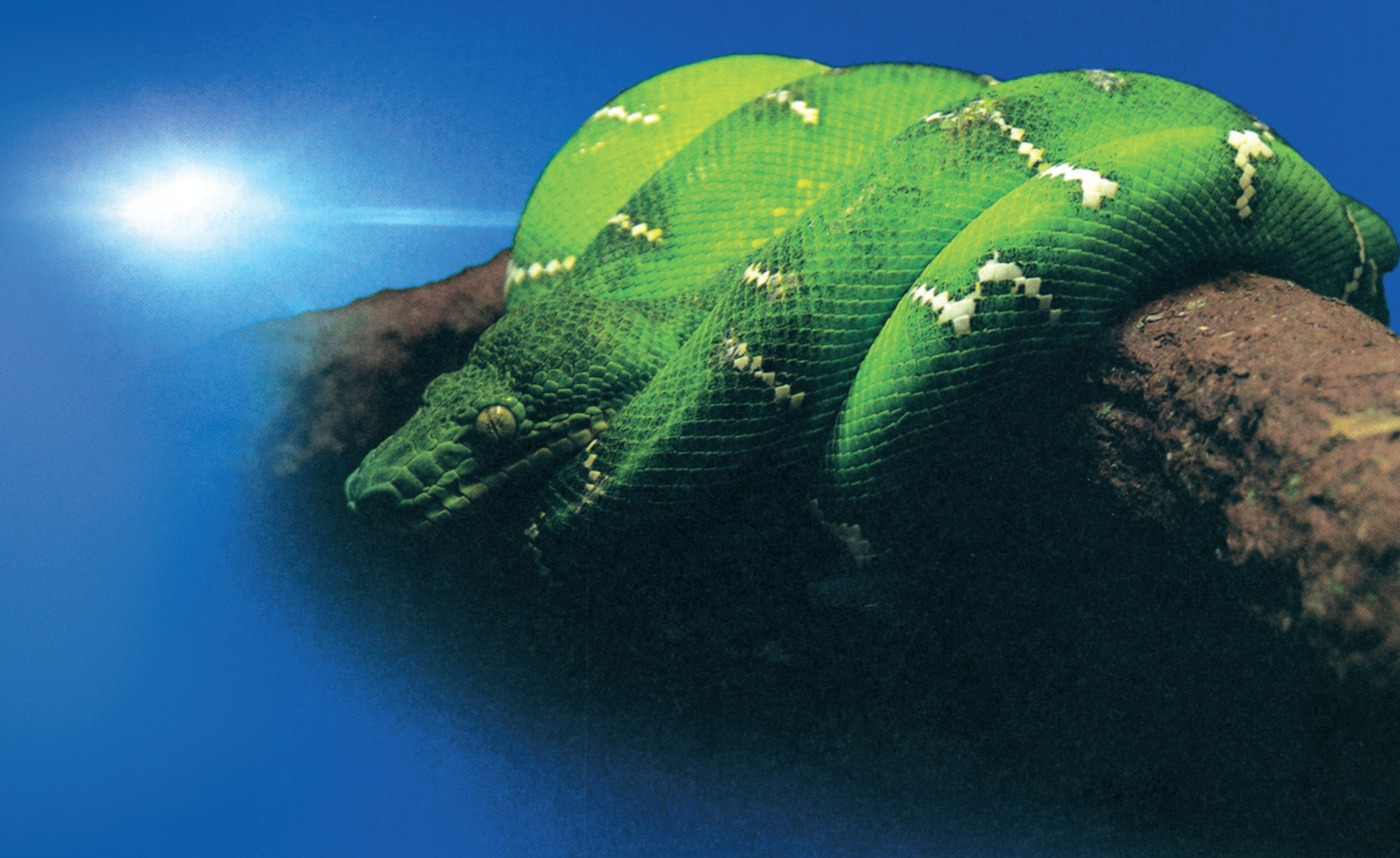

## Lathe chucks - Independent chucks

Key bar chucks with quick-acting jaw change system	3004
Lathe chucks ZS-ZSU	3020
Lathe chucks ZG-ZGU	3024
Lathe chucks ZGF	3032
Lathe chucks ZG Hi-Tru	3035
Lathe chucks EG-ES	3045
Lathe chucks KRF	3052
Jaw cutting attachment	3055
Adapter plates	3056
Steel independent chucks USE-USU	3058
Cast iron independent chucks UGE-UGU	3065



# Operation Guide

	Key bar chucks			Geared scroll chucks		
Type	DURO-T	DURO-TA <b>NEW</b>	ZS / ZSU	ZG / ZGU	ZGF	ZG Hi-Tru
Chucking capacities	3 - 646	3 - 646	2 - 1400	2 - 1400	(3 - 400)	2 - 315
Mount	DIN 6350 ISO 702-1 (DIN 55026) ISO 702-2 (DIN 55029) ISO 702-3 (DIN 55027)	DIN 6350 ISO 702-2 (DIN 55029) ISO 702-3 (DIN 55027)	DIN 6350 ISO 702-1 (DIN 55026) ISO 702-2 (DIN 55029) ISO 702-3 (DIN 55027) DIN 6350 BVV (mounting from front)	DIN 6350 ISO 702-1 (DIN 55026) ISO 702-2 (DIN 55029) ISO 702-3 (DIN 55027) DIN 6350 BVV (mounting from front)	DIN 6350 DIN 6350 BVV (mounting from front)	DIN 6350
Through-hole						
Number of jaws						
Types of jaws						
Workpiece						
Machining						
Rotating/ Stationary						
Clamping						
Clamping force						
Speed max.						
Precision						
Feature	quick-acting jaw change system	Grinding chuck with quick-acting jaw change system	with splash water groove and control edge	with splash water groove and control edge	soft top jaws	radial precision adjustment, with special seal for grinding machines
Page	3004	3014	3021	3024	3032	3035



Yes



2-jaw chuck



6-jaw chuck



disc



optional



3-jaw chuck



pipe



flange



No



4-jaw chuck



bar



asymmetrical workpiece



# Operation Guide

	Geared scroll chucks			Independent chucks	
Type	EG	ES	KRF	USE / USU	UGE / UGU
Chucking capacities	3 - 630	3 - 630	2-200	20 - 1270	8 - 1250
Mount	DIN 6350 ISO 702-1 (DIN 55026) ISO 702-2 (DIN 55029) ISO 702-3 (DIN 55027)	DIN 6350 ISO 702-1 (DIN 55026) ISO 702-2 (DIN 55029) ISO 702-3 (DIN 55027)	Cylindrical centre mount	Cylindrical centre mount ISO 702-1 (DIN 55026) ISO 702-2 (DIN 55029) ISO 702-3 (DIN 55027)	Cylindrical centre mount ISO 702-1 (DIN 55026) ISO 702-2 (DIN 55029) ISO 702-3 (DIN 55027)
Through-hole					
Number of jaws					
Types of jaws					
Workpiece	 	 	 	 	 
Machining					
Rotating/ Stationary					
Clamping					
Clamping force					
Speed max.					
Precision					
Feature	independently adjustable jaws	independently adjustable jaws			
Page	3046	3046	3052	3059	3065

Inside jaw + outside jaw	reversible jaw	Rotating	independently adjustable
base jaw	length machining	Stationary	
base- and top jaw	side machining	Self-centering	

# DURO-T

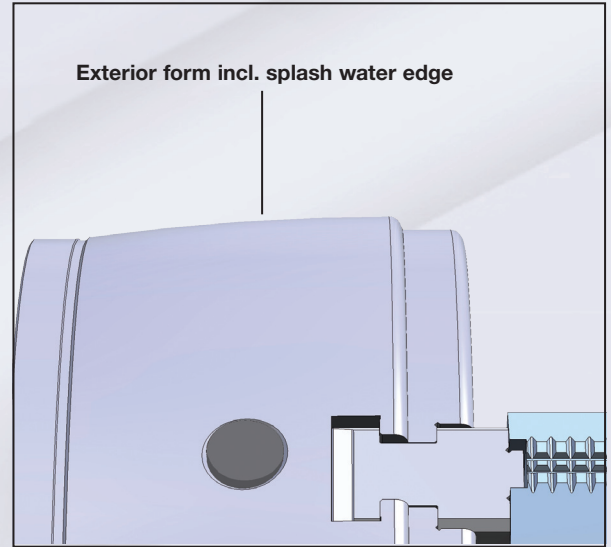

Scan QR-Code and watch the product video DURO-T at youtube!

## Technical features

### RÖHM DURO-T Manual chucks:

- high clamping forces
- Chuck body stiff (guarantees precision at higher loads)
- Surface of chuck body completely hardened
- Highly operator friendly
- Superior Design:
  - Indicator marks for quick jaw adjustment
  - Meaningful lettering engraved in body front face (i.e. chuck number, techn. details)
  - attractive, tared shape incl. drop-off wedge for water
- High jaw-changing repeatability
- Optimized wearing parts (i.e. safety lock)
- Chuck statically balanced
- Enhanced life at higher precision
- Radial and axial run-out tolerances only half of the permitted values according to the DIN-accuracy class 1
- Best corrosion prevention
- Lubrication possibility of the highly loaded sliding surfaces:
  - Spindle thread and spindle-counterface
  - wedge bars
  - drive ring
  - slides
- With safety key (required acc. DIN EN 1550)
- Base- and top-jaws of other manufacturers are compatible

Key bar chuck DURO-T, available in 3 various designs:



with reversible one-piece jaws

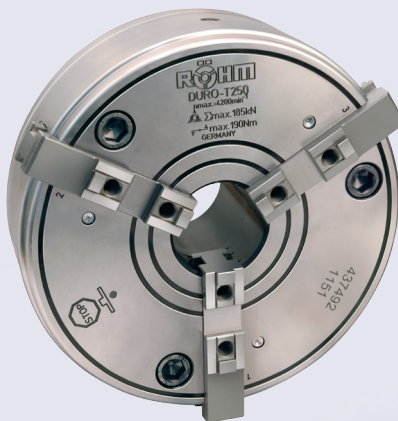

with base jaws



with base jaws and reversible top jaws



# DURO-T

The key bar chuck DURO-T ensures ultimate precision and highest clamping force. The DURO-T is statically balanced.

### Mechanism

The tangentially arranged operating screw (1) engages the internal thread of the actuating key bar (2) to move a slide (3) which in turn moves the drive ring. Two further slides in the drive ring (4) transmit the force to the other two key bars. The key bars are provided with helical teeth which engages the teeth of the base jaws (5) so that the workpiece is gripped accurately and concentrically. The jaws can be quickly and conveniently reversed, exchanged or relocated over the entire gripping range. After disengaging the key bar by turning the wrench counterclockwise, the indicator pin appears (7). In this position, the jaws are safely locked (6) against movement so that they cannot fly out if the machine spindle is started inadvertently. Each jaw must therefore be unlocked by pressing the corresponding pin (8) on the outside diameter of the chuck.

Large, straight surfaces transmitting the force from the key bar to the jaw teeth guarantee long life and produce a very high gripping force combined with an accuracy which is twice as high as required by DIN 6386. The high gripping force is achieved without much physical effort by manually turning the key.

### Lubrication

Lathe chucks must be lubricated regularly to maintain their gripping force. Appropriate directions are included in the operating instructions supplied with each chuck. All lathe chucks are equipped with grease nipples for convenient maintenance.

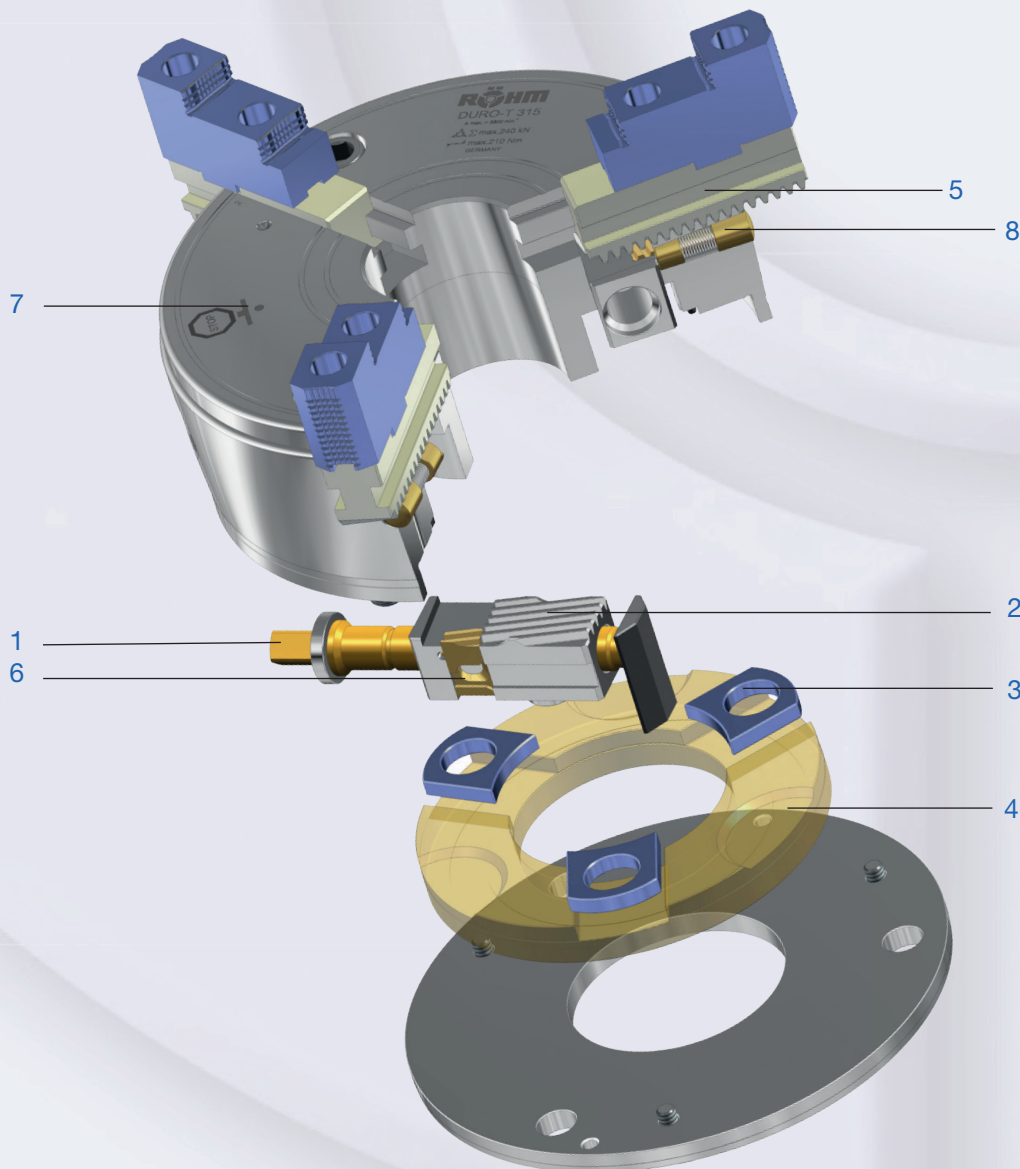

## DURO-T



DURO-T key bar chucks are successfully used wherever extremely high tension forces, high concentric accuracy and reliable continuous repeatability are needed.

For lathes. Suitable for milling machines, dividing attachments and machining centres in connection with a base plate, non rotating.

The jaws can be quickly and easily reversed, exchanged or relocated over the entire gripping range.

The jaws retain their accuracy if they are always used on the same chuck and when base jaws and top jaws are kept screwed together as a matched set for recurring work.

It is therefore advisable to stock several jaw sets.

### Technical features:

- with jaw safeguard
- stiff chuck body (guarantees precision at higher loads)
- indicator marks for quick jaw adjustment
- shape incl. drop-off edge for water
- radial and axial run-out tolerances only half of the permitted values according to the DIN-accuracy class 1
- lubrication possibility of the highly loaded sliding surfaces
- with safety key (required acc. DIN EN 1550)

### Customer advantage:

- highest clamping forces
- high jaw-changing repeatability
- optimized wearing parts
- best corrosion prevention
- base- and top-jaws of other manufacturers are compatible
- further sizes on request

Tool group A08  
Key bar chucks DURO-T  
cylindrical centre mount

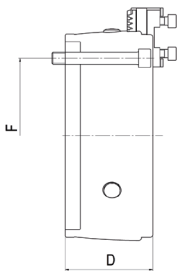

Size	Inch	Through-hole	with one-piece reversible jaws	with base jaws	with base jaws and reversible top jaws	D	Speed max. min <sup>-1</sup>	Max. Torque Nm	Max. total clamping force kN
125	5	32	437475 ●	437482 ●	-	46,5	6000	40	23
160	6 1/4	42	437476 ●	437483 ●	437490 ●	63	5400	120	73
200	8	52	437477 ●	437484 ●	437491 ●	81	4600	155	114
250	10	62	437478 ●	437485 ●	437492 ●	92	4200	190	185
315	12 1/2	87	437479 ●	437486 ●	437493 ●	111	3300	210	240
400	15 3/4	102	437480 ●	437487 ●	437494 ●	118	2200	260	260
500	20	162	437481 ●	437488 ●	437495 ●	118	1900	320	290
630	25	252	-	437489 <sup>1)</sup> ●	437496 ●	143	1100	350	320

Further sizes on request

1) at size 630 chuck body without convex outer contours

Tool group A08  
Key bar chucks DURO-T  
ISO 702-1 (DIN 55026), DIN 55021,  
ASA B 5.9, mounting from front

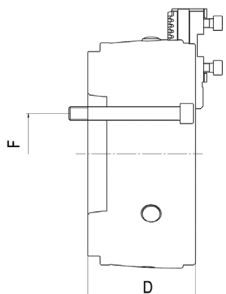

Size	Mount short taper	Through-hole	with one-piece reversible jaws	with base jaws	with base jaws and reversible top jaws	D	F	Speed max. min <sup>-1</sup>	Max. Torque Nm	Max. total clamping force kN
160	4	42	437570 ●	437580 ●	437591 ●	76	82,62	5400	120	73
160	5	42	437571 ●	437581 ●	437592 ●	79	104,8	5400	120	73
200	5	52	437572 ●	437582 ●	437593 ●	93	104,8	4600	155	114
200	6	52	437573 ●	437583 ●	437594 ●	97	133,4	4600	155	114
250	6	62	437574 ●	437584 ●	437595 ●	108	133,4	4200	190	185
315	6	87	437575 ●	437585 ●	437596 ●	124	133,4	3300	210	240
315	8	87	437576 ●	437586 ●	437597 ●	130	171,4	3300	210	240
400	8	102	437577 ▲	437587 ▲	437598 ▲	135	171,4	2200	260	260
500	11	162	437578 ▲	437588 ▲	437599 ▲	138	235	1900	320	290
630	15	252	-	437590 <sup>1)</sup> ▲	437601 ▲	167	330,2	1100	350	320

Further sizes on request

1) at size 630 chuck body without convex outer contours



## DURO-T

Tool group A08  
Key bar chucks DURO-T  
ISO 702-3 (DIN 55027),  
with studs and locknuts

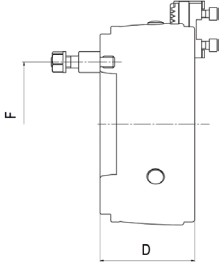

Size	Mount short taper	Through-hole	with one-piece reversible jaws	with base jaws	with base jaws and reversible top jaws	D	F	Speed max. min <sup>-1</sup>	Max. Torque Nm	Max. total clamping force kN
125	3	32	437497 ■	437521 ■	-	60	75	6000	40	23
125	4	32	437498 ■	437522 ■	-	60	85	6000	40	23
125	5	32	437499 ■	437523 ■	-	67	104,8	6000	40	23
160	4	42	437500 ■	437524 ■	437547 ■	76	85	5400	120	73
160	5	42	437501 ●	437525 ●	437548 ●	78	104,8	5400	120	73
160	6	42	437502 ■	437526 ■	437549 ■	85	133,4	5400	120	73
200	4	52	437503 ■	437527 ■	437550 ■	94	85	4600	155	114
200	5	52	437504 ■	437528 ■	437551 ●	96	104,8	4600	155	114
200	6	52	437505 ●	437529 ■	437552 ●	97	133,4	4600	155	114
200	8	52	437506 ●	437530 ■	437553 ■	108	171,4	4600	155	114
250	4	60	437507 ■	437531 ■	437554 ■	105	85	4200	190	185
250	5	62	437508 ■	437532 ■	437555 ■	107	104,8	4200	190	185
250	6	62	437509 ●	437533 ■	437556 ●	108	133,4	4200	190	185
250	8	62	437510 ■	437534 ■	437557 ●	110	171,4	4200	190	185
315	6	87	437511 ■	437535 ■	437558 ■	127	133,4	3300	210	240
315	8	87	437512 ●	437536 ●	437559 ●	129	171,4	3300	210	240
315	11	87	437513 ■	437537 ■	437560 ■	131	235	3300	210	240
400	6	102	437514 ▲	437538 ▲	437561 ▲	138	133,4	2200	260	260
400	8	102	437515 ▲	437539 ▲	437562 ▲	138	171,4	2200	260	260
400	11	102	437516 ▲	437540 ▲	437563 ▲	138	235	2200	260	260
400	15	102	437517 ▲	437541 ▲	437564 ▲	160	330,2	2200	260	260
500	8	135	437518 ▲	437542 ▲	437565 ▲	156	171,4	1900	320	290
500	11	162	437519 ▲	437543 ▲	437566 ▲	156	235	1900	320	290
500	15	162	437520 ▲	437544 ▲	437567 ▲	163	330,2	1900	320	290
630	11	192	-	437545 <sup>1)</sup> ▲	437568 ▲	165	235	1100	350	320
630	15	252	-	437546 <sup>1)</sup> ▲	437569 ▲	167	330,2	1100	350	320

Further sizes on request

1) at size 630 chuck body without convex outer contours

Tool group A08  
Key bar chucks DURO-T  
ISO 702-2 (DIN 55029),  
Stud for Camlock

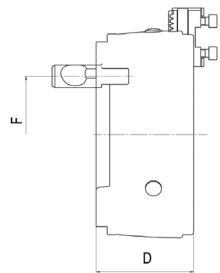

Size	Mount short taper	Through-hole	with one-piece reversible jaws	with base jaws	with base jaws and reversible top jaws	D	F	Speed max. min <sup>-1</sup>	Max. Torque Nm	Max. total clamping force kN
125	3	32	437602 ■	437625 ■	-	67	70,66	6000	40	23
125	4	32	437603 ■	437626 ■	-	68	82,6	6000	40	23
160	4	42	437604 ■	437627 ■	437650 ■	83,5	82,6	5400	120	73
160	5	42	437605 ■	437628 ■	437651 ■	87	104,8	5400	120	73
160	6	42	437606 ■	437629 ■	437652 ■	104	133,4	5400	120	73
200	4	52	437607 ■	437630 ■	437653 ■	97,5	82,6	4600	155	114
200	5	52	437608 ■	437631 ■	437654 ■	101	104,8	4600	155	114
200	6	52	437609 ■	437632 ■	437655 ■	106	133,4	4600	155	114
200	8	52	437610 ■	437633 ■	437656 ■	125	171,4	4600	155	114
250	4	60	437611 ■	437634 ■	437657 ■	118,5	82,6	4200	190	185
250	5	62	437612 ■	437635 ■	437658 ■	112	104,8	4200	190	185
250	6	62	437613 ■	437636 ■	437659 ■	117	133,4	4200	190	185
250	8	62	437614 ■	437637 ■	437660 ■	120	171,4	4200	190	185
315	6	87	437615 ■	437638 ■	437661 ■	145	133,4	3300	210	240
315	8	87	437616 ■	437639 ■	437662 ■	136	171,4	3300	210	240
315	11	87	437617 ■	437640 ■	437663 ■	143	235	3300	210	240
400	6	102	437618 ■	437641 ■	437664 ■	153	133,4	2200	260	260
400	8	102	437619 ■	437642 ■	437665 ■	141	171,4	2200	260	260
400	11	102	437620 ■	437643 ■	437666 ■	148	235	2200	260	260
400	15	102	437621 ■	437644 ■	437667 ■	168	330,2	2200	260	260
500	8	135	437622 ▲	437645 ▲	437668 ▲	143	171,4	1900	320	290
500	11	162	437623 ▲	437646 ▲	437669 ▲	148	235	1900	320	290
500	15	162	437624 ▲	437647 ▲	437670 ▲	153	330,2	1900	320	290
630	11	192	-	437648 <sup>1)</sup> ▲	437671 ▲	170	235	1100	350	320
630	15	252	-	437649 <sup>1)</sup> ▲	437672 ▲	175	330,2	1100	350	320

Further sizes on request

1) at size 630 chuck body without convex outer contours

## Jaws DURO-T

Tool group A28  
Type 000 **One-piece jaw EB**,  
set hardened

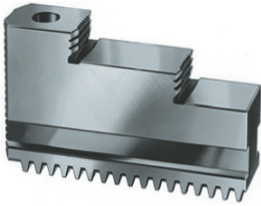

Item no.	Chuck Size	Number of jaws	Contents of delivery	Jaw length	Jaw height	Jaw width
212121 ●	125	3	set	50	34	14
094000 ●	160	3	set	77,7	45	20
094001 ●	200	3	set	94,7	60	22
094002 ●	250	3	set	114	70	26
094003 ●	315	3	set	130	79	32
094043 ●	400/500	3	set	167	93	45

Stepped and hardened jaws, supplied as supplement or as spares, must be ground on the chuck.  
In case of a subsequent jaw delivery please return the chuck.

Tool group A28  
Type 000 **Unstepped Jaw BL**, set  
unstepped, soft, material 16MnCr5

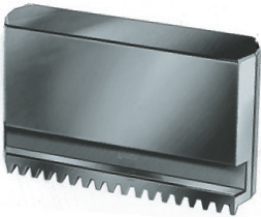

Item no.	Chuck Size	Number of jaws	Contents of delivery	Jaw length	Jaw height	Jaw width
304864 ●	125	3	set	53	34	14
241699 ●	160	3	set	84,4	45	20
249678 ●	200	3	set	98,4	60	22
249679 ●	250	3	set	118,7	70	26
249680 ●	315	3	set	136,6	79	32
249681 ●	400/500	3	set	173,6	93	45

Tool group A28  
Type 003 **Reversible top jaw UB**,  
set  
hardened

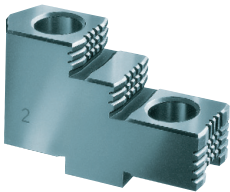

Item no.	Chuck Size	Number of jaws	Contents of delivery	Jaw length	Jaw height	Jaw width
094012 ●	160	3	set	61,5	32,5	20,4
094013 ●	200	3	set	70,5	38	24,4
094014 ●	250	3	set	92	50	34,4
094015 ●	315	3	set	107	56	35,7
094045 ●	400/500	3	set	130	72	50,4
140715 ●	630	3	Satz	185	102	68

Hardened jaws, supplied as supplement or as spares, must be ground on the chuck.  
In case of a subsequent jaw delivery please return the chuck.

Tool group A28  
Type 002 **Unstepped top jaw AB**, set  
standard design, soft,  
material 16MnCr5

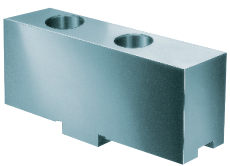

Item no.	Chuck Size	Number of jaws	Contents of delivery	Jaw length	Jaw height	Jaw width
212123 ●	125	3	set	55	25,5	20,7
094008 ●	160	3	set	85	36,5	20,3
094009 ●	200	3	set	105	40	22
094010 ●	250	3	set	125	50	30,4
094011 ●	315	3	set	145	50	34,3
094046 ●	400/500	3	set	180	73	50,5
140716 ●	630	3	set	260	102	68

Tool group A28  
Type 002 **Unstepped top jaw AB**, set  
extendend design, soft,  
material 16MnCr5

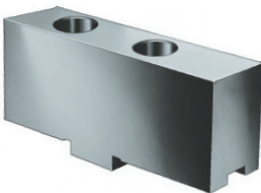

Item no.	Chuck Size	Number of jaws	Contents of delivery	Jaw length	Jaw height	Jaw width
137055 ●	160	3	set	85	42,5	24,4
137056 ●	200	3	set	105	51	34,3
137057 ●	250	3	set	125	75	50,5
137058 ●	315	3	set	145	74	50,5

Tool group A28  
Type 002 **Base jaw GB**, set  
with mounting bolts

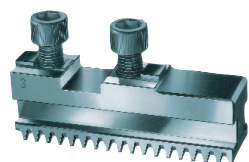

Item no.	Chuck Size	Number of jaws	Contents of delivery	Jaw length	Jaw width
212119 ●	125	3	set	47	14
094004 ●	160	3	set	74	20
094005 ●	200	3	set	90	22
094006 ●	250	3	set	110	26
094007 ●	315	3	set	125	32
094044 ●	400/500	3	set	160	45
140194 ●	630	3	set	230	65



## Jaws DURO-T

Tool group C 21  
Type 544-00 **reversible claw-type top jaws, standard design** tongue and groove, **small clamping range**, 1 piece hardened

Item no.	Chuck Size	Jaw length	Jaw height	Jaw width
137060 ●	160	66	37,5	24
137119 ●	400/500	124	62	50
151289 ■	630	144	78	70

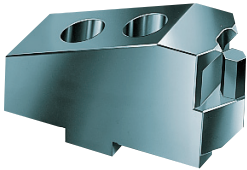

Tool group C 21  
Type 544-00 **reversible claw-type top jaws, standard design** tongue and groove, **large clamping range**, 1 piece, hardened

Item no.	Chuck Size	Jaw length	Jaw height	Jaw width
137061	160	66	37,5	20
137064 ●	200	81	43	24
137108 ●	250	90	55	34
137114 ●	315	100	62	34
137120	400/500	124	62	50

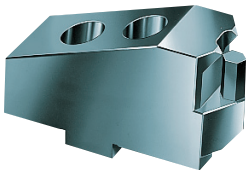

Tool group C 21  
Type 544-00 **reversible claw-type top jaws, standard design** tongue and groove, **middle sized clamping range**, 1 piece, hardened

Item no.	Chuck Size	Jaw length	Jaw height	Jaw width
137062 ●	160	56	37,5	20
137065 ●	200	66	43	24
137109 ●	250	72	55	34
137115 ●	315	86	62	34
137121 ●	400/500	100	62	50

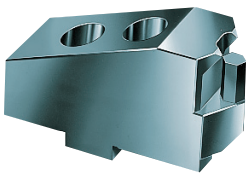

Tool group C 21  
Type 544-05 **reversible claw-type top jaws, large design** tongue and groove, **small clamping range**, 1 piece, hardened

Item no.	Chuck Size	Jaw length	Jaw height	Jaw width
137066 ●	160/200	79	43	34
137110 ●	250	80	55	50
137116 ●	315	93	62	50

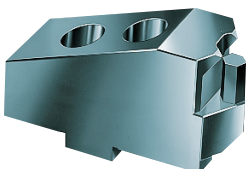

Tool group C 21  
Type 544-05 **reversible claw-type top jaws, large design** tongue and groove, **large clamping range**, 1 piece, hardened

Item no.	Chuck Size	Jaw length	Jaw height	Jaw width
137067 ●	160/200	81	43	34
137111 ●	250	90	55	50
137117 ●	315	106	62	50

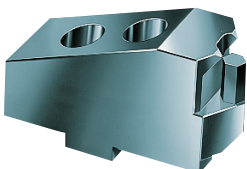

Tool group C 21  
Type 544-05 **reversible claw-type top jaws, large design** tongue and groove, **middle sized clamping range**, 1 piece, hardened

Item no.	Chuck Size	Jaw length	Jaw height	Jaw width
137068 ●	160/200	66	43	34
137112 ●	250	72	55	50
137118 ●	315	86	62	50

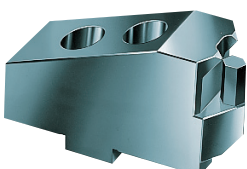

## Jaws DURO-T

Tool group C 21  
Type 545-00 **Draw-down jaws**,  
without clamping inserts  
**diagonally toothed**, 1 piece,  
without clamping inserts

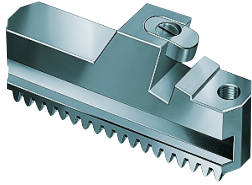

Item no.	Chuck Size	Jaw length	Jaw height	Jaw width
141037 ●	160	84,4	43,5	20
141039 ●	200	98,4	47,5	22
141041 ●	250	118,7	58,5	26
141043 ●	315	136,4	63,9	32
141045 ●	400/500	173,6	73,4	45

Tool group C 21  
Type 545-00 **Draw-down jaws**,  
**additional clamping range**, for  
interchangeable clamping inserts  
**diagonally toothed**, 1 piece,  
without clamping inserts

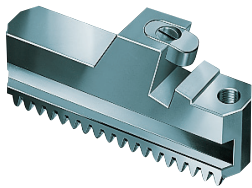

Item no.	Chuck Size	Jaw length	Jaw height	Jaw width
141038 ●	160	84,4	43,5	20
141040 ●	200	98,4	47,5	22
141042 ●	250	118,7	58,5	26
141044 ●	315	136,4	63,9	32
141046 ●	400	173,6	73,4	45
141048 ●	500	173,6	73,4	45

Tool group C 15  
Type 545-60 **Interchangeable  
clamping inserts**, 1 piece  
**with claws**

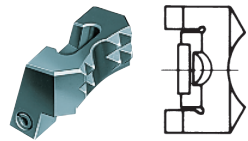

Item no.	Chuck Size
151029 ●	125
141049 ●	160/200
141052 ●	250/315
141055 ●	400/500/630

Tool group C 15  
Type 545-70 **Interchangeable  
clamping inserts**, 1 piece  
**with serrated toothed**

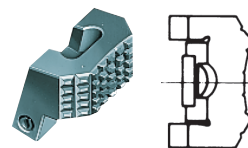

Item no.	Chuck Size
151039 ●	125
141050 ●	160/200
141053 ●	250/315
141056 ●	400/500

Tool group C 15  
Type 545-80 **Interchangeable  
clamping inserts**, 1 piece  
**with heat treatable surface**

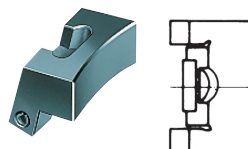

Item no.	Chuck Size
151040 ●	125
141051 ●	160/200
141054 ●	250/315
141057 ●	400/500

Tool group C15  
Type 0040-Y **Jaw mounting bolt**,  
piece



Item no.	Contents of delivery	Size	Thread
243893 ●	Stück	125	M6x10
200182 ●	piece	160/200	M8x1x22
200183 ●	piece	250	M12x1,5x30
202402 ●	piece	315	M12x1,5x35
227618 ●	piece	400/500	M16x1,5x40
249388 ●	piece	630	M20x50

## Accessories DURO-T

Tool group A08

Type 004 **Rough adaptor plate** for DURO-chucks with **cylindrical centre mount**

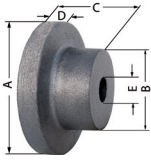

Item no.	Chuck Size	A	B	C	D	E
206652 <span style="color: yellow;">■</span>	160	155	80	60	40	30
206653 <span style="color: yellow;">■</span>	200	195	80	65	40	40
206654 <span style="color: yellow;">■</span>	250	245	120	90	45	50
206655 <span style="color: yellow;">■</span>	314	310	165	100	45	50
229081 <span style="color: yellow;">■</span>	400	390	230	130	50	70
241780 <span style="color: yellow;">■</span>	500	475	240	145	50	80

Tool group A08

Type 000 **Base plate with fixing slots** complete with mounting screws and fixed T-slot nuts. Other sizes available on request.



Item no.	Size
143163 <span style="color: yellow;">■</span>	160
143165 <span style="color: yellow;">■</span>	200
143167 <span style="color: yellow;">■</span>	250

Tool group A08

Type 000 **Key**



Item no.	Size	Square	L
212124 <span style="color: green;">●</span>	125	8	85
094016 <span style="color: green;">●</span>	160	10	140
094017 <span style="color: green;">●</span>	200	12	160
094018 <span style="color: green;">●</span>	250	14	220
094019 <span style="color: green;">●</span>	315	17	230
094047 <span style="color: green;">●</span>	500	19	250
332938 <span style="color: green;">●</span>	630	24	410

only for stationary used chucks

Tool group A08

Type 000 **Safety key**



Item no.	Size	Square	L
242172 <span style="color: green;">●</span>	125	8	85
242173 <span style="color: green;">●</span>	160	10	140
242174 <span style="color: green;">●</span>	200	12	160
242175 <span style="color: green;">●</span>	250	14	220
242176 <span style="color: green;">●</span>	315	17	230
242177 <span style="color: green;">●</span>	500	19	250
332939 <span style="color: green;">●</span>	630	24	410

corresponding with DIN 1550 for rotating chucks

Tool group A08

Type 000 **Chip guard, set**



Item no.	Contents of delivery	Size
212122 <span style="color: yellow;">■</span>	set	125
236439 <span style="color: yellow;">■</span>	set	160
236440 <span style="color: green;">●</span>	set	200
236441 <span style="color: green;">●</span>	set	250
236442 <span style="color: green;">●</span>	set	315
236443 <span style="color: green;">●</span>	set	500

Tool group A08

Type 1028 **Special grease F80 for lathe chucks** for lubrication and conservation of chucking power



Item no.	Design	Contents
630886 <span style="color: green;">●</span>	tube	0,1 kg
308555 <span style="color: green;">●</span>	Cartridge	0,5 kg
028975 <span style="color: green;">●</span>	Tin	1 kg



# Technical Data DURO-T

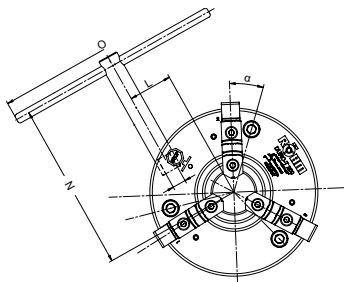
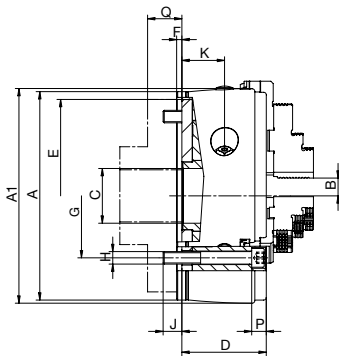

Chuck size A		125	160	200	250	315	400	500	630
Outer-Ø	A1	128	164	206	256	322	407	507	630
Jaw movement	B	4,8	6,2	6,8	8	10,2	12,5	12,5	14
Bore	C	32	42	52	62	87	102	162	252
Bore can be enlarged	C max.	35	45	55	75	102	130	180	270
	D	46,5	63	81	92	111	118	118	143
	E <sup>H6</sup>	115	145	185	235	300	380	460	580
	F	4	5	5	6	6	6	6	6
	G	100	125	160	200	250	315	400	520
	H	3xM8	3xM10	3xM12	3xM16	3xM20	3xM24	3xM24	3xM24
	J	12	15	18	25	30	37	37	37
	K	22,5	31,5	43	47	59	57,7	57,5	72
	L	32,5	42	53,5	66,5	86	110	152,5	196
	M	SW8	SW10	SW12	SW14	SW17	SW19	SW19	SW24
	N	117	182	211	284	309	359	356	570
	O	180	210	270	450	500	600	600	600
	P	8,5	13	14	17	21	25	25	29
Min. thickness of flange	Q	17	30	30	35	35	40	45	55
Moment of inertia GD2 <sup>1)</sup>	kgm <sup>2</sup>	0,01	0,03	0,10	0,29	0,87	2,37	5,78	17,04
	α	21° 35'	22°	18°	19°	17°	20°	42°	69° 30'
approx. kg	kg	4,0	9,3	18,6	34,5	64	112	166	300

1) The moment of inertia was measured with base jaws but without top jaws or back plate

The bore could be enlarged (measure C, at surcharge)

Enlarged bore max.

### Max. permissible speed

The maximum permissible speed has been fixed so that 1/3 of the gripping force is still available as residual gripping force if the maximum gripping is applied and the chuck is fitted with its heaviest jaws. The jaws may not project beyond the outside diameter of the chuck. The chuck must be in perfect condition. The specification DIN 6386 Part 1 shall be observed.

Chuck size		125	160	200	250	315	400	500	630
Max. speed	min <sup>-1</sup>	6000	5400	4600	4200	3300	2200	1900	1100

### Gripping force

The gripping force is the sum total of all jaw forces acting radially on the stationary workpiece.

The specified gripping forces are standard values.

They apply to chucks in a perfect condition which have been lubricated with RÖHM grease F79 and F80.

Chuck size		125	160	200	250	315	400	500	630
Torque applied on key 1)	Nm	10	40	60	70	80	90	100	100
Total gripping force 1)	kN	8,5	30	48	66	80	95	102	102
Torque applied on key	Nm	40	120	155	190	210	260	320	350
Max. total gripping force	kN	23	73	114	185	240	260	290	320

1) Maintaining the accuracy

At this torque the clamping jaws have been ground at the factory, for testing the chuck must be clamped with this torque

### Chuck capacities of jaw steps

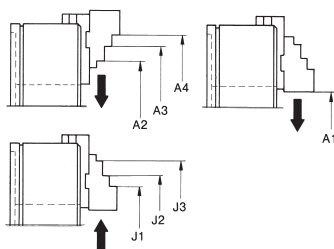

Chuck size		125	160	200	250	315	400	500	630
External chucking	A1	3-30	5-51	7-70	8-97	12-131	16-168	40-256	20-322
	A2	31-65	45-91	58-123	82-172	93-216	119-278	167-360	200-490
	A3	63-97	89-135	114-179	-	-	-	-	-
Internal chucking	A4	95-129	115-161	142-207	163-253	201-323	260-413	308-501	360-650
	J1	26-59	67-105	71-131	99-182	102-213	120-272	166-360	184-489
	J2	57-91	93-132	99-159	-	-	-	-	-
	J3	89-123	135-174	154-214	178-261	207-319	260-412	306-500	341-646

# Jaw dimensions DURO-T

Reversible one-piece jaw EB, hardened and ground, jaw steps not ground

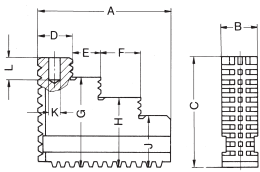

Block jaw BL, unstepped, soft, thread and jaw guides hardened and ground

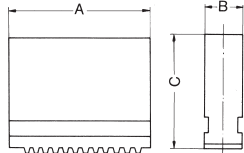

Chuck size	125	160	200	250	315	400+500
A	50	77,7	94,7	114	130	167
B	14	20	22	26	32	45
C	34	45	60	70	79	93
D	10,7	20,6	23	41,5	40,2	50,5
E	16	18,9	19,5	40,3	54	71
F	16	22	28	-	-	-
G	29	37,5	50	56	64	73
H	24	30	40	-	-	-
J	19	22,5	30	42	49	53
K	-	8	10	13	13	20
L	-	16	15	19,5	19,5	30
Jaw approx. kg	0,400	0,500	0,635	1,135	1,835	3,665

Chuck size	125	160	200	250	315	400+500
A	53	84,4	98,4	118,7	136,6	173,6
B	14	20	22	26	32	45
C	34	45	60	70	79	93
Jaw approx. kg	0,435	0,500	0,900	1,535	2,400	5

Reversible top jaw UB, completely hardened, cross tenon ground, jaw steps not ground

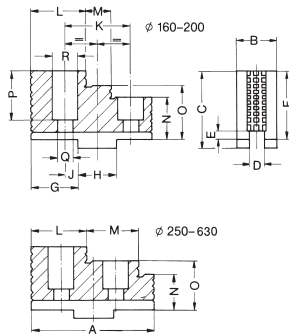

Chuck size	160	200	250	315	400+500	630
A	61,5	70,5	92	107	130	185
B	20,4	24,4	34,4	35,7	50,4	68
C	37	43	55	62	79	110
D	8	10	12	12	18	24
E	3	3,5	3,5	3,5	4,5	4,5
F	32,5	38	50	56	72	102
G	22,5	25,5	30	35,5	41,4	59
H	18	20	20	26	30	40
J	7	10	10	14	15	21
K	32	40	40	54	60	82
L	26,5	28,5	41	40	51	80
M	13	14	40,5	54	71	80
N	17,5	18	22	26	32	42
O	25	28	36	41	52	72
P	23,5	29	39	40	57	82
Q	9	9	14	14	18	22
R	15	15	20	20	26	33
T <sup>1)</sup>	38,5	45	57	63,6	80,6	114
Jaw approx. kg	0,200	0,335	0,800	1,135	2,535	6,350

1) Dimension marked on base jaw

Unstepped soft top jaw AB, for turning out special chucking diameters

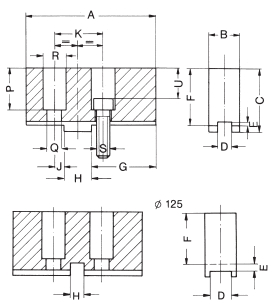

Chuck size	125	160	200	250	315	400+500	630				
A	55	85	105	125	145	180	260				
B	20,7	20,3	24,4	22	34,3	30,4	50,5	68			
C	31,3	41	47	45	56	55	80	110			
D	14	8	8	10	10	12	12	18	24		
E	3,3	3	3	3,5	3,5	3,5	3,5	4,5	4,5		
F	25,5	36,5	42,5	40	51	50	75	50	74	73	102
G	25	42	42	50	50	70	70	74	74	100	150
H	5	18	18	20	20	20	26	26	26	30	40
J	7,5	7	7	10	10	10	14	14	14	15	21
K	20	32	32	40	40	40	40	54	54	60	82
P	24	27,5	33,5	31	42	39	54	34	48	58	83
Q	6,5	9	9	9	14	14	14	14	14	18	22
R	11	15	15	15	20	20	20	20	20	26	33
S	M6	M8x1	M8x1	M8x1	M12x1,5	M12x1,5	M12x1,5	M12x1,5	M12x1,5	M16x1,5	M20
T <sup>1)</sup>	32	42,5	48,5	47	58	57	72	57,6	71,6	81,6	114
U	18	19,5	25,5	23	34	27	42	22	36	42	63
Jaw approx. kg	0,200	0,435	0,600	0,735	1,400	1,500	3,700	2,265	4,800	4,500	13,350

1) Dimension marked on base jaw

Base jaws GB, hardened and ground

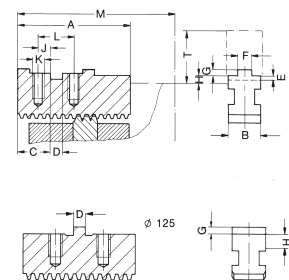

Chuck size	125	160	200	250	315	400+500	630	
A	47	74	90	110	125	160	230	
B	14	20	22	26	32	45	65	
C	21	19	23	26	30	35	52	
D	5	18	20	20	26	30	40	
E	-	5	5,5	5,5	6,5	7,5	9	
F	-	8	10	12	12	18	24	
G	2,8	2,5	3	3	3	4	4	
H	3,55	6	7	7	7,6	8,6	12	
J	7,5	7	10	10	14	15	21	
K	M6	M8x1	M8x1	M12x1,5	M12x1,5	M16x1,5	M20	
L	20	32	40	40	54	60	82	
M	72	103	129	163	196	250	294	399
Jaw approx. kg	0,200	0,265	0,365	0,700	1,065	2,350	5,665	

## DURO-TA - sealed design



DURO-key bar chucks are successfully used wherever extremely high tension forces, high concentric accuracy and reliable continuous repeatability are needed.

### For use on grinding machines.

The jaws can be quickly and easily reversed, exchanged or relocated over the entire gripping range.

The jaws retain their accuracy if they are always used on the same chuck and when base jaws and top jaws are kept screwed together as a matched set for recurring work.

It is therefore advisable to stock several jaw sets.

### Technical features:

- with cover for protection against dust on the face
- with jaw safeguard
- self-centering
- steel body, jaw guides hardened and ground
- high speeds
- lathe chucks must be lubricated regularly to maintain their gripping force
- further sizes on request

Tool group A08  
Key bar chucks DURO-TA  
cylindrical centre mount

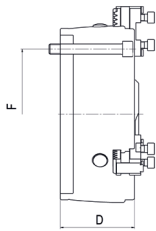

Size	Inch	with base jaws	with base jaws and reversible top jaws	D	Speed max. min <sup>-1</sup>	Max. Torque Nm	Max. total clamping force kN
160	6 1/4	439606 ▲	439605 ▲	63	5400	120	73
200	8	439608 ▲	439607 ▲	81	4600	155	114
250	10	439610 ▲	439609 ▲	92	4200	190	185

Further sizes on request

Tool group A08  
Key bar chucks DURO-TA  
ISO 702-3 (DIN 55027),  
with studs and locknuts

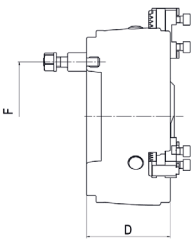

Size	Mount short taper	with base jaws	with base jaws and reversible top jaws	D	F	Speed max. min <sup>-1</sup>	Max. Torque Nm	Max. total clamping force kN
160	4	439612 ▲	439611 ▲	63	82,6	5400	120	73
160	5	439614 ▲	439613 ▲	63	104,8	5400	120	73
200	4	439616 ▲	439615 ▲	81	82,6	4600	155	114
200	5	439618 ▲	439617 ▲	81	104,8	4600	155	114
200	6	439620 ▲	439619 ▲	81	133,4	4600	155	114
250	4	439622 ▲	439621 ▲	92	82,6	4200	190	185
250	5	439624 ▲	439663 ▲	92	104,8	4200	190	185
250	6	439626 ▲	439625 ▲	92	133,4	4200	190	185

Further sizes on request

Tool group A08  
Key bar chucks DURO-TA  
ISO 702-2 (DIN 55029),  
Stud for Camlock

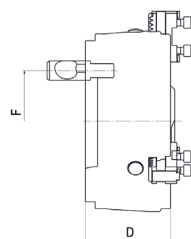

Size	Mount short taper	with base jaws	with base jaws and reversible top jaws	D	F	Speed max. min <sup>-1</sup>	Max. Torque Nm	Max. total clamping force kN
160	4	439628 ▲	439627 ▲	63	82,6	5400	120	73
160	5	439630 ▲	439629 ▲	63	104,8	5400	120	73
200	4	439632 ▲	439631 ▲	81	82,6	4600	155	114
200	5	439634 ▲	439633 ▲	81	104,8	4600	155	114
200	6	439636 ▲	439635 ▲	81	133,4	4600	155	114
250	4	439638 ▲	439637 ▲	92	82,6	4200	190	185
250	5	439640 ▲	439639 ▲	92	104,8	4200	190	185
250	6	439642 ▲	439641 ▲	92	133,4	4200	190	185

Further sizes on request



## Jaws DURO-TA

Tool group A28  
Type 000 **Outside jaw DB**, set  
inward stepped jaw, hardened

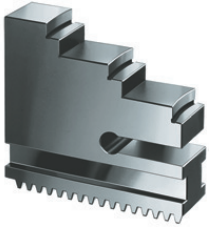

Item no.	Chuck Size	Jaw width
329041 <span style="color: yellow;">■</span>	160	20
329042 <span style="color: yellow;">■</span>	200	22
329043 <span style="color: yellow;">■</span>	250	26

Stepped and hardened jaws, supplied as supplement or as spares, must be ground on the chuck.  
In case of a subsequent jaw delivery please return the chuck.

Tool group A28  
Type 000 **Inside jaw BB**, set  
outward stepped jaw, hardened

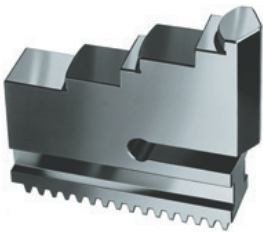

Item no.	Chuck Size	Jaw width
329038 <span style="color: yellow;">■</span>	160	20
329039 <span style="color: yellow;">■</span>	200	22
329040 <span style="color: yellow;">■</span>	250	26

Stepped and hardened jaws, supplied as supplement or as spares, must be ground on the chuck.  
In case of a subsequent jaw delivery please return the chuck.

Tool group A28  
Type 002 **Unstepped top jaw AB**, set  
soft, material 16MnCr5



Item no.	Chuck Size	Jaw length	Jaw height	Jaw width
329044 <span style="color: yellow;">■</span>	160	90	36,5	20,3
329045 <span style="color: yellow;">■</span>	200	100	40	22
094010 <span style="color: green;">●</span>	250	125	50	30,4

Tool group A28  
Type 002 **Base jaw GB**, set  
hardened, with mounting bolts

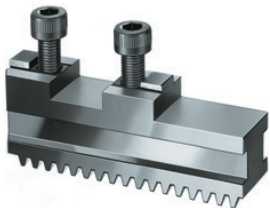

Item no.	Chuck Size	Jaw length	Jaw height	Jaw width
329047 <span style="color: yellow;">■</span>	160	74	8	20
329048 <span style="color: yellow;">■</span>	200	90	10	22
329049 <span style="color: yellow;">■</span>	250	110	12	26

Tool group C15  
Type 0040-Y **Jaw mounting bolt**,  
piece



Item no.	Contents of delivery	Size	Thread
200182 <span style="color: green;">●</span>	piece	160/200	M8x1x22
200183 <span style="color: green;">●</span>	piece	250	M12x1,5x30

## Accessories DURO-TA

Tool group A08

Type 004 **Rough adaptor plate** for DURO-chucks with cylindrical centre mount

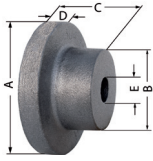

Item no.	Chuck Size	A	B	C	D	E
206652	160	155	80	60	40	30
206653	200	195	80	65	40	40
206654	250	245	120	90	45	50
206655	314	310	165	100	45	50
229081	400	390	230	130	50	70
241780	500	475	240	145	50	80

Tool group A08

Type 000 **Base plate with fixing slots** complete with mounting screws and fixed T-slot nuts. Other sizes available on request.



Item no.	Size
143163	160
143165	200
143167	250

Tool group A08

Type 000 **Key**



Item no.	Size	Square	L
212124	125	8	85
094016	160	10	140
094017	200	12	160
094018	250	14	220
094019	315	17	230
094047	500	19	250
332938	630	24	410

only for stationary used chucks

Tool group A08

Type 000 **Safety key**



Item no.	Size	Square	L
242172	125	8	85
242173	160	10	140
242174	200	12	160
242175	250	14	220
242176	315	17	230
242177	500	19	250
332939	630	24	410

corresponding with DIN 1550 for rotating chucks

Tool group A08

Type 000 **Chip guard, set**



Item no.	Contents of delivery	Size
212122	set	125
236439	set	160
236440	set	200
236441	set	250
236442	set	315
236443	set	500

Tool group A08

Type 1028 **Special grease F80 for lathe chucks** for lubrication and conservation of chucking power



Item no.	Design	Contents
630886	tube	0,1 kg
308555	Cartridge	0,5 kg
028975	Tin	1 kg

# Technical data DURO-TA

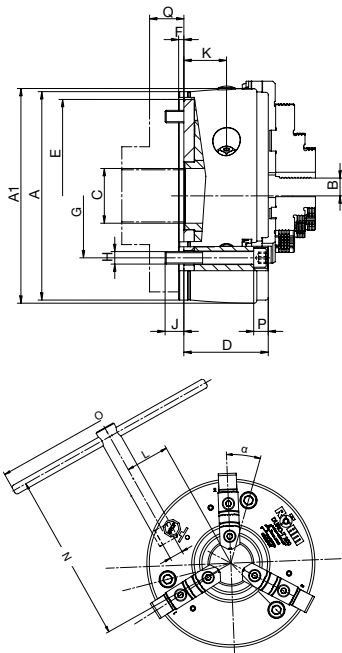

Chuck size		160	200	250
Outer diameter	A	160	206	255
Jaw movement	B	6,2	6,8	8
Bore	C	42	52	62
Bore can be enlarged	C max.	45	55	75
	D	63	81	92
	E <sup>H6</sup>	145	185	235
	F	5	5	6
	G	125	160	200
	H	3xM10	3xM12	3xM16
	J	15	18	25
	K	31,5	43	47
	L	42	53,5	66,5
	M	SW10	SW12	SW14
	N	182	211	284
	O	210	270	450
	P	13	14	17
Min. thickness of flange	Q	30	30	35
Moment of inertia <sup>1)</sup>	kgm <sup>2</sup>	0,03	0,10	0,29
	α	22°	18°	19°
Weight approx	kg	9,5	20°	35

1) The moment of inertia was measured with base jaws but without top jaws or back plate

The bore could be enlarged (measure C, at surcharge)

■ Enlarged bore max.

### Max. permissible speed

The maximum permissible speed has been fixed so that 1/3 of the gripping force is still available as residual gripping force if the maximum gripping is applied and the chuck is fitted with its heaviest jaws. The jaws may not project beyond the outside diameter of the chuck. The chuck must be in perfect condition. The specification DIN 6386 Part 1 shall be observed.

Chuck size		160	200	250
Max. speed	min <sup>-1</sup>	5400	4600	4200

### Gripping force

The gripping force is the sum total of all jaw forces acting radially on the stationary workpiece.

The specified gripping forces are standard values.

They apply to chucks in a perfect condition which have been lubricated with RÖHM grease F79 and F80.

Chuck size		160	200	250
Torque applied on key in1)	Nm	20	30	35
Total gripping force1)	kN	15	24	33
Torque applied on key in	Nm	120	155	190
Max. total gripping force	kN	73	114	185

1) Maintaining the accuracy

### Chucking capacities of jaw steps

Chuck size		160	200	250	
External chucking	Jaw position.	A1	5-51	7-70	8-97
		A2	45-91	58-123	82-172
		A3	89-135	114-179	-
		A4	115-161	142-207	163-253
Internal chucking		J1	67-105	71-131	99-182
		J2	93-132	99-159	-
		J3	135-174	154-214	178-261

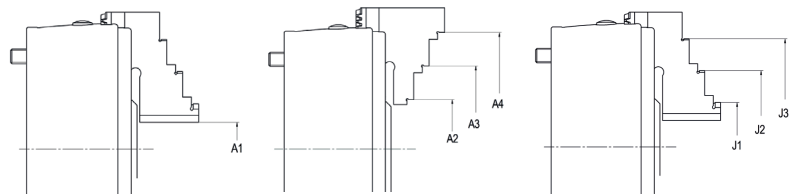
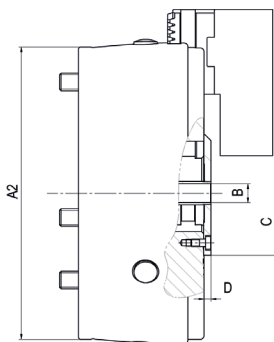

Chuck dimensions DURO-TA - Main dimensions (other dimensions on the table on the top)

Chuck size		160	200	250
Outer diameter	A	160	206	255
External chucking with BB-jaws		3-46	3-60	5-66
External chucking with DB-jaws		23-160	32-200	65-243
Internal chucking with BB jaws		28-156	32-195	47-225
Central bor for coolant	B	13	13	13
	C	70	85	92
	D	5	6	5



# Jaw dimensions and chucking capacity DURO-TA

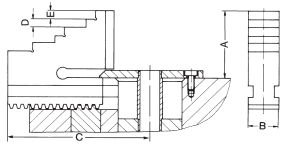

Outward stepped jaw BB

Chuck size	160	200	250
A	46	55	60
B	20	22	26
C max.	95	120	143,5
C min.	72	91	113
D	5	7	6
E	6	6	8
Jaw approx. kg	0,465	0,643	1,065

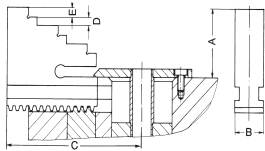

Inward stepped jaw DB

Chuck size	160	200	250
A	43	50	50
B	20	22	26
C max.	95	120	143,5
C min.	72	91	113
D	5	7	6
E	6	6	8
Jaw approx. kg	0,435	0,600	1,065

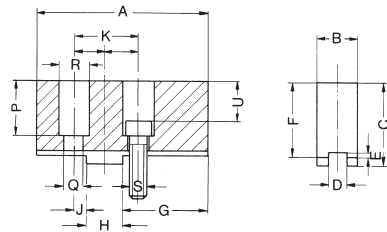

Unstepped soft top jaw AB

Chuck size	160	200	250
A	90	100	125
B	20,3	22	30
C	41	45	55
D	8	10	12
E	3	3,5	3,5
F	36,5	40	50
G	55	61	70
H	18	20	20
J	6	6	10
K	30	32	40
P	27,5	31	39
Q	9	9	14
R	15	15	20
S	M8x1	M8x1	M12x1,5
U	19,5	23	27
Jaw approx. kg	0,435	0,800	1,500

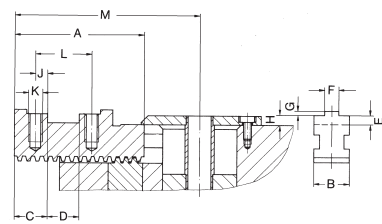

Base jaw GB

Chuck size	160	200	250
A	74	90	110
B	20	22	26
C	17	19	26
D	18	20	20
E	5	5,5	5,5
F	8	10	12
G	2,5	7	7
H	6	20	20
J	7	6	10
K	M8x1	M8x1	M12x1,5
L	32	32	40
M max.	105	127	148,5
M min.	91	103	125
Jaw approx. kg	0,335	0,365	0,700

# Pendulum bridges - InoZet

With InoZet® you can turn your existing 3-jaw chuck into a highly flexible, compensating 6-jaw chuck in no time at all!

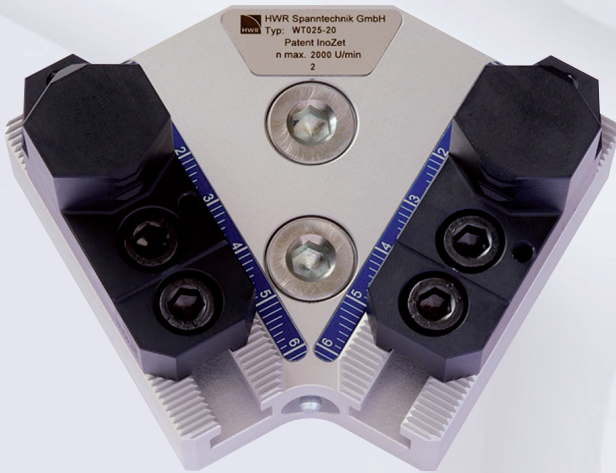

Thanks to the variable positioning of the clamping jaws on the pendulum segments, you can cover the entire clamping range with one set of standard clamping jaws, so that you have maximum flexibility. You need neither countless pendulum clamping jaws nor any special constructions – which leads to enormous cost savings.

**InoZet® offers:**

- maximum flexibility
- significant cost advantages
- outstanding turning results thanks to its technical superiority

**Traditional 3-point clamping**

Strong deformation by only 3 clamping points and high tension pressure. As a consequence the component runs out of true (polygon forming).

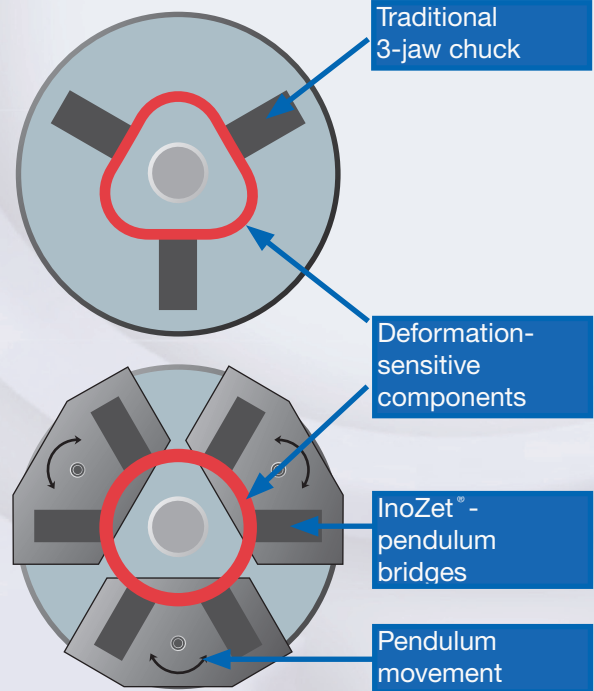

**Function principle**

The InoZet®-pendulum bridges can be mounted on the base jaws of the existing chuck. The bridges are compensating and allow a low-deformation 6-point clamping by the pendulum mechanism.

It is possible to mount hard gripper jaws for machining unfinished parts, as well as soft jaws for finishing by centrally running teeth on the pendulum bridges.

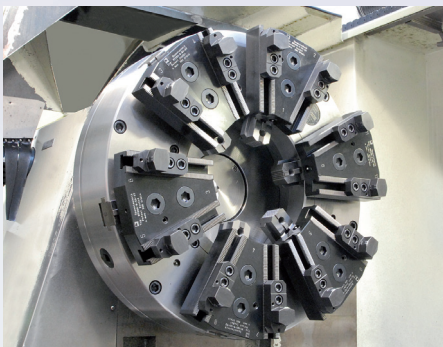

With InoZet® -pendulum bridges six jaws become twelve

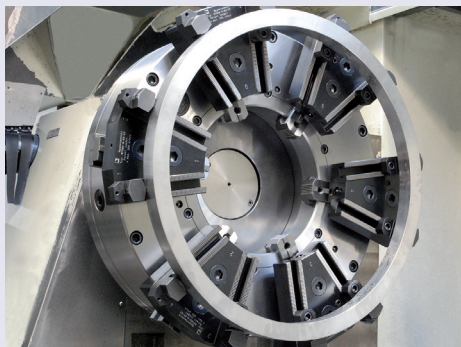

For clamping thin walled workpieces

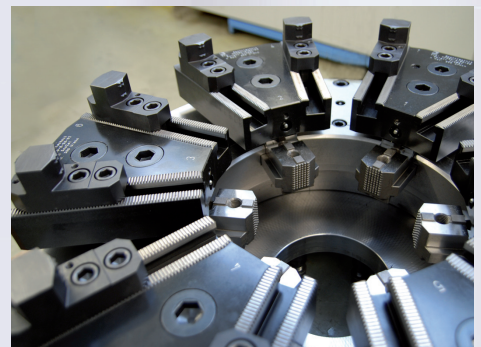

Variable positioning of the clamping jaws on the pedulum segments

## Geared scroll chuck with optimized design

Benefit from proven quality in optimized design. A splash water edge at the upper chuck edge is used as additional protection of the spindle against coolant. A control edge on the chuck body enables a quick and simple adjustment of the spiral ring chuck on the machine and the new security adapter allows a defined torque with a torque wrench, especially for deformation-sensitive workpieces. These chucks are used successfully in areas which requires very high clamping forces, high concentricity and high repeatability.

Spiral ring chucks available up to 3000mm diameter. Please contact us!

### Mechanism

The radial positioned Pinion (4) transmits the power via a bevel gearing to the Spiral Ring (3), where the spiral transmits it to the Jaws (5). Steel or cast iron body (1), Control edge (7), Cover (2).

### Lubrication

Lathe chucks must be lubricated regularly to maintain their gripping force. Appropriate directions are included in the operating instructions supplied with each chuck. All lathe chucks are equipped with grease nipples for convenient maintenance.

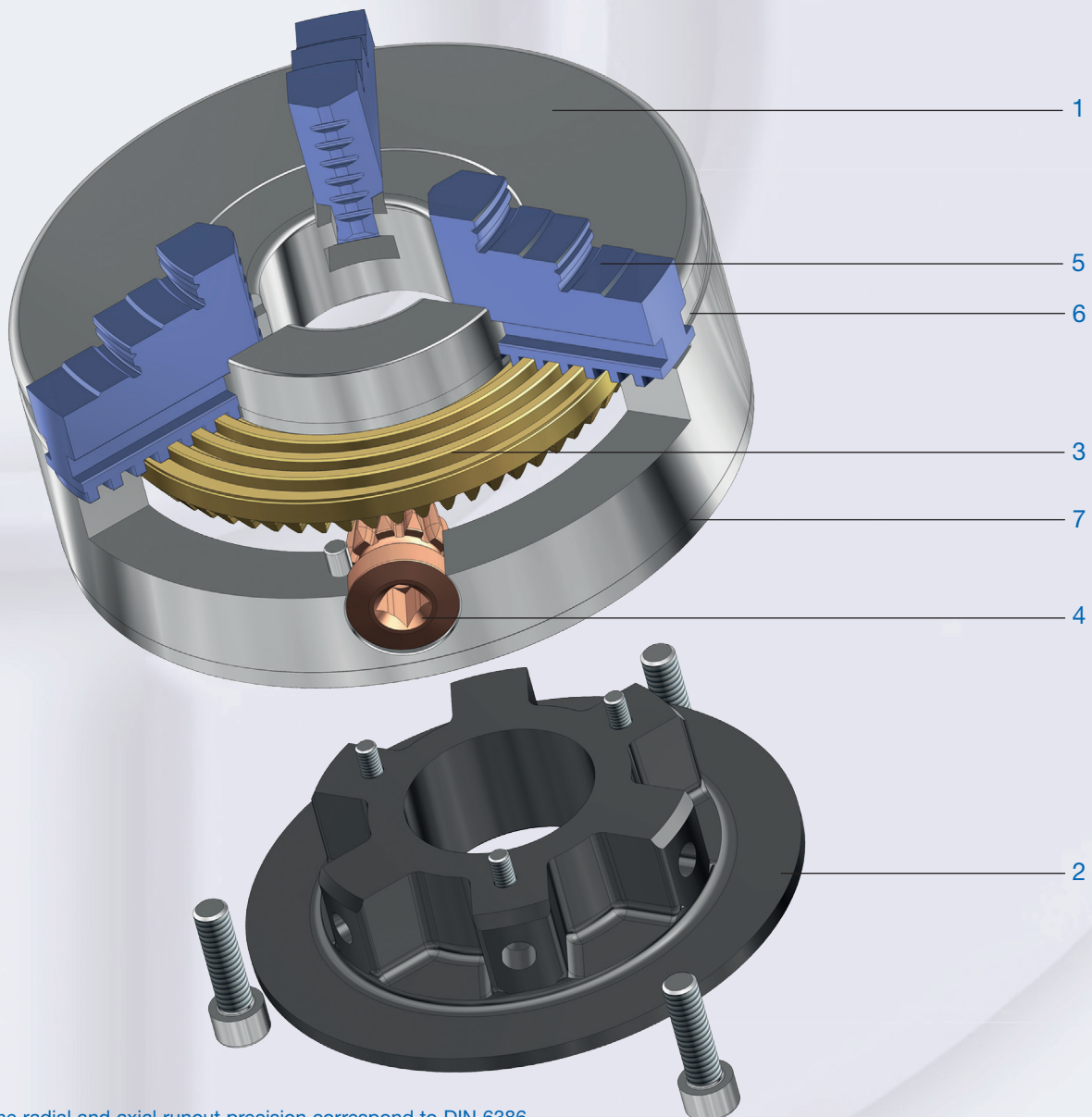

The radial and axial runout precision correspond to DIN 6386 Part 1 Precision Class 1 (high precision chuck)



## Basic - ZS-ZSU



The spiral ring chuck - a proven and universal suitable clamping system - finds its application wherever a high clamping force, high runout accuracy and very high repeatability are required. For use on lathes, rotary tables, dividing heads, etc.

The jaws can be moved across the entire clamping range by turning a key. Due to this, workpieces with different diameters can be clamped without changing or shifting the jaws. Special flat design with direct mounting.

### Technical features:

- with one-piece jaws or with base and reversible top jaws
- with scroll
- self-centering
- self-centering
- chuck body: drop-forged steel or special cast iron
- scroll: drop-forged and balanced, hardened
- lathe chucks must be lubricated regularly to maintain their gripping force
- further sizes on request

### Delivery includes (BB and DB):

- 1 set of outward stepped jaws (BB) mounted in the chuck,
- 1 set of inward stepped jaws (DB),
- 1 operating key, mounting bolts

### Delivery includes (GB and UB):

- 1 set of base jaws (GB),
- 1 set of reversible top jaws (UB),
- 1 operating key, mounting bolts

Tool group A09  
Geared scroll chucks ZS-ZSU  
DIN 6350; cylindrical centre mount,  
form A

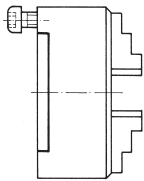

Size	ZA	Through-hole	3 jaw chuck with inside and outside jaw	4 jaw chuck with inside and outside jaw	3 jaw chuck with base and reversible top jaw	4 jaw chuck with base and reversible top jaw	6 jaw chuck with inside and outside jaw	Speed max. min <sup>-1</sup>	Torque Nm	Total clamping force kN
80	56	19	102513 ●	102505 ●	-	-	-	7000	30	13
100	70	20	101782 ●	102130 ●	101788 ■	102136 ▲	-	6300	60	27
125	95	32	101672 ●	106075 ●	101678 ■	106081 ▲	138363 ▲	5500	80	31
140	105	40	105784 <sup>1)</sup> ●	105800 ■	105790 ▲	105806 ▲	118456 ▲	5000	90	40
160	125	42	100717 ●	101164 ●	100725 ■	101170 ■	121289 ▲	4600	110	47
200	160	55	100186 ●	100466 ●	100189 ●	100484 ■	114407 ▲	4000	140	55
250	200	76	100533 ●	101030 ●	100541 ●	143989 ▲	114408 ▲	3000	150	63
315	260	103	101344 ●	101598 ●	101350 ■	151278 ▲	122227 ▲	2300	180	69
350	290	115	104800 <sup>1)</sup> ■	104936 ▲	104803 ▲	176060 ▲	176059 ▲	1900	210	74
400	330	136	102062 ●	102330 ■	102068 ■	149048 ▲	123857 ▲	1800	240	92
500	420	190	102555 ■	103340 ▲	102585 ■	152602 ▲	153884 ▲	1300	260	100
630	545	240	102720 ▲	102856 ▲	102726 ■	144048 ▲	143993 ▲	850	280	105
700	610	310	-	-	147501 ▲	147515 ▲	-	800	280	105
800	710	380	-	-	104913 ▲	104917 ▲	-	700	300	110
1000	910	460	-	-	104925 ▲	104929 ▲	-	560	450	115
1250	910	550	-	-	104941 ▲	104945 ▲	-	450	450	115

<sup>1)</sup> intermediate size

Tool group A09  
Geared scroll chucks ZS-ZSU  
mounting from front; cylindrical  
centre mount

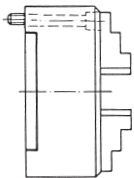

Size	ZA	Through-hole	3 jaw chuck with inside and outside jaw	4 jaw chuck with inside and outside jaw	Speed max. min <sup>-1</sup>	Torque Nm	Total clamping force kN
125	95	32	120155 ●	124447 ■	5500	80	31
160	125	42	115568 ●	125802 ■	4600	110	47
200	160	55	113158 ●	113160 ■	4000	140	55
250	200	76	114304 ■	114306 ■	3000	150	63
315	260	103	120270 ■	129946 ■	2300	180	69
400	330	136	123475 ▲	134401 ▲	1800	240	92
500	420	190	127616 ▲	123465 ▲	1300	260	100
630	545	240	128545 ▲	135061 ▲	850	280	105

## Basic - ZS-ZSU

Tool group A09  
Geared scroll chucks ZS-ZSU  
ISO 702-3 (DIN 55027); with studs  
and locknuts, optional DIN 55021  
with set screw and nut

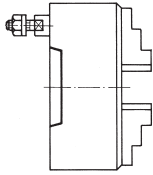

Size	Mount short taper	Through-hole	3 jaw chuck with inside and outside jaw	4 jaw chuck with inside and outside jaw	3 jaw chuck with base and reversible top jaw	4 jaw chuck with base and reversible top jaw	Speed max. min <sup>-1</sup>	Torque Nm	Total clamping force kN
100	3	20	102106 ▲	102154 ▲	102112 ▲	102160 ▲	6300	60	27
125	3	32	101688 ▲	107007 ▲	101691 ▲	107013 ▲	5500	80	31
125	4	32	101692 ●	107015 ▲	101695 ▲	107021 ▲	5500	80	31
140	3	40	105556 ▲	105569 ▲	105742 ▲	105759 ▲	5000	90	40
140	4	40	105557 ●	105570 ▲	105743 ▲	105760 ▲	5000	90	40
140	5	40	105558 ●	105571 ▲	105744 ▲	105761 ▲	5000	90	40
160	3	42	105032 ▲	105072 ▲	105035 ▲	105075 ▲	4600	110	47
160	4	42	100740 ●	101184 ▲	100743 ▲	101187 ▲	4600	110	47
160	5	42	100744 ●	101188 ●	100747 ▲	101191 ▲	4600	110	47
200	3	51,2	100160 ▲	101430 ▲	100163 ▲	101436 ▲	4000	140	55
200	4	55	100164 ▲	101438 ▲	100167 ▲	101444 ▲	4000	140	55
200	5	55	100152 ●	100472 ●	100155 ▲	101420 ▲	4000	140	55
200	6	55	100156 ●	101422 ●	100159 ●	101428 ▲	4000	140	55
250	4	60,7	123124 ▲	123125 ▲	127870 ▲	127880 ▲	3000	150	63
250	5	76	100557 ▲	101052 ▲	100566 ▲	101061 ▲	3000	150	63
250	6	76	100555 ●	101050 ●	100564 ●	101059 ●	3000	150	63
250	8	76	100556 ●	101051 ●	100565 ▲	101060 ▲	3000	150	63
315	5	79,6	111193 ▲	127863 ▲	127871 ▲	127881 ▲	2300	180	69
315	6	103	101364 ●	101919 ▲	101373 ▲	101922 ▲	2300	180	69
315	8	103	101365 ●	101923 ▲	101374 ▲	101926 ▲	2300	180	69
315	11	103	101366 ●	101927 ▲	101375 ▲	101930 ▲	2300	180	69
350	6	103	104824 ▲	104960 ▲	104827 ▲	104963 ▲	1900	210	74
350	8	115	104816 ▲	104952 ▲	104819 ▲	104955 ▲	1900	210	74
350	11	115	104820 ▲	104956 ▲	104823 ▲	104959 ▲	1900	210	74
400	6	103	102218 ▲	101892 ▲	102224 ▲	101898 ▲	1800	240	92
400	8	136	102202 ▲	101876 ▲	102208 ▲	101882 ▲	1800	240	92
400	11	136	102210 ▲	101884 ▲	102216 ▲	101890 ▲	1800	240	92
500	8	136	104413 ▲	105656 ▲	104456 ▲	105666 ▲	1300	260	100
500	11	190	102548 ▲	102971 ▲	102554 ▲	102977 ▲	1300	260	100
500	15	190	102915 ▲	103227 ▲	102921 ▲	103233 ▲	1300	260	100
630	11	192,7	102752 ▲	102888 ▲	102758 ▲	102894 ▲	850	280	105
630	15	240	102760 ▲	103084 ▲	102766 ▲	103090 ▲	850	280	105
700	11	192,7	-	-	147503 ▲	147517 ▲	800	280	105
700	15	281,2	-	-	147505 ▲	147519 ▲	800	280	105
800	11	192,7	-	-	148253 ▲	149067 ▲	700	300	110
800	15	281,2	-	-	129339 ▲	129355 ▲	700	300	110
800	20	380	-	-	129340 ▲	129356 ▲	700	300	110
1000	15	281,2	-	-	129341 ▲	129357 ▲	450	450	115
1000	20	407,5	-	-	129342 ▲	129358 ▲	450	450	115
1250	15	281,2	-	-	129343 ▲	129359 ▲	450	450	115
1250	20	407,5	-	-	129344 ▲	129360 ▲	450	450	115

Tool group A09  
Geared scroll chucks ZS-ZSU  
ISO 702-1 (DIN 55026); DIN 55021,  
ASA B 5.9, A1/A2 metr.;  
mounting from front

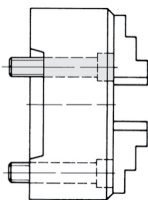

Size	Mount short taper	Through-hole	3 jaw chuck with inside and outside jaw	4 jaw chuck with inside and outside jaw	3 jaw chuck with base and reversible top jaw	4 jaw chuck with base and reversible top jaw	Speed max. min <sup>-1</sup>	Torque Nm	Total clamping force kN
160	5	42	100753 <sup>1)</sup> ▲	101196 ▲	100757 ▲	101199 ▲	4600	110	47
200	5	42	100168 <sup>1)</sup> ▲	101446 ▲	100172 ▲	101452 ▲	4000	140	55
200	6	55	100173 <sup>1)</sup> ▲	101454 ▲	100177 ▲	101460 ▲	4000	140	55
250	5	76	100571 ▲	101064 ▲	100580 ▲	101073 ▲	3000	150	63
250	6	55	100567 <sup>1)</sup> ▲	101062 ▲	100578 ▲	101071 ▲	3000	150	63
250	8	76	100569 <sup>1)</sup> ▲	101063 ▲	100579 ▲	101072 ▲	3000	150	63
315	6	103	101376 ▲	101931 ▲	101385 ▲	101937 ▲	2300	180	69
315	8	76	101377 <sup>1)</sup> ▲	101939 ▲	101386 ▲	101945 ▲	2300	180	69
350	6	103	114643 ▲	127557 ▲	127848 ▲	127850 ▲	1900	210	74
350	8	76	117319 <sup>1)</sup> ▲	117320 ▲	127847 ▲	127849 ▲	1900	210	74
400	8	136	102226 ▲	102353 ▲	102232 ▲	102359 ▲	1800	240	92
400	11	125	102234 <sup>1)</sup> ▲	102361 ▲	102240 ▲	102367 ▲	1800	240	92
500	11	190	102562 ▲	102979 ▲	102568 ▲	102985 ▲	1300	260	100
630	11	190	102768 ▲	102896 ▲	102774 ▲	103002 ▲	850	280	105
630	15	190	102784 <sup>1)</sup> ▲	103012 ▲	102790 ▲	103018 ▲	850	280	105
700	11	193	-	-	147507 ▲	147521 ▲	650	280	105
700	15	281,2	-	-	147509 ▲	147523 ▲	650	280	105
800	11	193	-	-	139200 ▲	139234 ▲	600	300	110
800	15	281,2	-	-	129347 ▲	129363 ▲	600	300	110
800	20	380	-	-	129348 ▲	129364 ▲	600	300	110
1000	15	281,2	-	-	129349 ▲	129365 ▲	480	450	115
1000	20	407,5	-	-	129350 ▲	129366 ▲	480	450	115
1250	15	281,2	-	-	129351 ▲	129367 ▲	380	450	115
1250	20	407,5	-	-	129352 ▲	129368 ▲	380	450	115

<sup>1)</sup> mounting from front in the inner bolt circle

## Basic - ZS-ZSU

Tool group A09  
Geared scroll chucks ZS-ZSU  
ISO 702-2 (DIN 55029); ASA B 5.9,  
Type D, with studs for Camlock

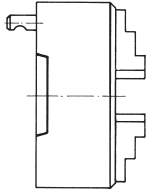

Size	Mount short taper	Through-hole	3 jaw chuck with inside and outside jaw	4 jaw chuck with inside and outside jaw	3 jaw chuck with base and reversible top jaw	4 jaw chuck with base and reversible top jaw	Speed max. min <sup>-1</sup>	Torque Nm	Total clamping force kN
100	3	20	108890 ▲	109203 ▲	105846 ▲	105848 ▲	6300	60	27
125	3	32	108891 ●	109204 ▲	105858 ▲	105862 ▲	5500	80	31
125	4	32	108895 ■	109208 ▲	105870 ▲	105872 ▲	5500	80	31
140	3	40	108892 ▲	109205 ▲	-	-	5000	90	40
140	4	40	108896 ■	109209 ▲	-	-	5000	90	40
140	5	40	108899 ▲	109212 ▲	-	-	5000	90	40
160	3	42	108893 ■	-	-	-	4600	110	47
160	4	42	108897 ●	109210 ●	105882 ▲	105886 ▲	4600	110	47
160	5	42	109150 ●	109213 ●	105898 ▲	106302 ▲	4600	110	47
200	3	51,2	108894 ▲	109207 ▲	106362 ▲	106366 ▲	4000	140	55
200	4	55	108898 ●	109211 ■	106374 ▲	106376 ▲	4000	140	55
200	5	55	109151 ●	109214 ●	106330 ■	106334 ▲	4000	140	55
200	6	55	109154 ●	109217 ■	106346 ▲	106350 ▲	4000	140	55
250	4	60,7	127861 ▲	127866 ▲	127874 ▲	127884 ▲	3000	150	63
250	5	76	109152 ■	109215 ▲	106418 ▲	106422 ▲	3000	150	63
250	6	76	109155 ●	109218 ●	106386 ▲	106390 ▲	3000	150	63
250	8	76	109159 ●	109222 ■	106402 ▲	106406 ▲	3000	150	63
315	5	79,6	127862 ▲	127867 ▲	127875 ▲	127885 ▲	2300	180	69
315	6	103	109156 ■	109219 ▲	106442 ▲	106446 ▲	2300	180	69
315	8	103	109160 ●	109223 ■	106458 ▲	106462 ▲	2300	180	69
315	11	103	109165 ■	109228 ▲	106474 ▲	106478 ▲	2300	180	69
350	6	103	109158 ▲	109221 ▲	106806 ▲	106810 ▲	1900	210	74
350	8	115	109162 ▲	109225 ▲	106674 ▲	106678 ▲	1900	210	74
350	11	115	109169 ▲	109232 ▲	106690 ▲	106694 ▲	1900	210	74
400	6	103	109157 ▲	109220 ▲	106630 ▲	106634 ▲	1800	240	92
400	8	136	109161 ▲	109224 ▲	106498 ▲	106602 ▲	1800	240	92
400	11	136	109166 ▲	109229 ▲	106614 ▲	106618 ▲	1800	240	92
500	8	136	109163 ▲	109226 ▲	105625 ▲	105684 ▲	1300	260	100
500	11	190	109167 ▲	109230 ▲	103274 ▲	106646 ▲	1300	260	100
500	15	190	109170 ▲	109233 ▲	103275 ▲	103271 ▲	1300	260	100
630	11	192,7	109168 ▲	109231 ▲	106658 ▲	106662 ▲	850	280	105
630	15	240	109171 ▲	109234 ▲	103328 ▲	106251 ▲	850	280	105
700	11	192,7	-	-	147511 ▲	147525 ▲	800	280	105
700	15	281,2	-	-	147513 ▲	147527 ▲	800	280	105
800	11	192,7	-	-	146526 ▲	168101 ▲	700	300	110
800	15	281,2	-	-	129371 ▲	129379 ▲	700	300	110
800	20	380	-	-	129372 ▲	129380 ▲	700	300	110
1000	15	281,2	-	-	129373 ▲	129381 ▲	560	450	115
1000	20	407,5	-	-	129374 ▲	129382 ▲	560	450	115
1250	15	281,2	-	-	129375 ▲	129383 ▲	450	450	115
1250	20	407,5	-	-	129376 ▲	129384 ▲	450	450	115

## Economy - ZG-ZGU



The spiral ring chuck - a proven and universal suitable clamping system - finds its application wherever a high clamping force, high runout accuracy and very high repeatability are required. For use on lathes, rotary tables, dividing heads, etc.

The jaws can be moved across the entire clamping range by turning a key. Due to this, workpieces with different diameters can be clamped without changing or shifting the jaws.

Special flat design with direct mounting.

### Technical features:

- with one-piece jaws or with base and reversible top jaws
- with scroll
- self-centering
- chuck body: drop-forged steel or special cast iron with scroll
- with scroll
- scroll: drop-forged and balanced, hardened
- lathe chucks must be lubricated regularly to maintain their gripping force
- further sizes on request

### Delivery includes (BB and DB):

- 1 set of outward stepped jaws (BB) mounted in the chuck,
- 1 set of inward stepped jaws (DB),
- 1 operating key, mounting bolts

### Delivery includes (GB and UB):

- 1 set of base jaws (GB),
- 1 set of reversible top jaws (UB),
- 1 operating key, mounting bolts

Tool group A09  
Geared scroll chucks ZG-ZGU  
DIN 6350; cylindrical centre mount,  
form A

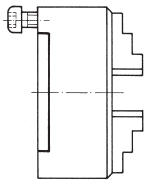

Size	ZA	Through-hole	3 jaw chuck with inside and outside jaw	4 jaw chuck with inside and outside jaw	3 jaw chuck with base and reversible top jaw	4 jaw chuck with base and reversible top jaw	Speed max. min <sup>-1</sup>	Torque Nm	Total clamping force kN
74	56	15	102528 <sup>1)</sup> ●	-	-	-	5000	30	11
80	56	19	102509 ●	102501 ●	-	-	5000	30	13
85	60	19	112537 <sup>2)</sup> ●	112591 ▲	-	-	5000	30	13
100	70	20	101781 ●	102129 ●	101787 ●	102135 ▲	4500	60	27
110	80	27	112538 <sup>2)</sup> ●	112592 ●	114433 ▲	114357 ▲	4300	60	27
125	95	32	101628 ●	106074 ●	101634 ●	106080 ▲	4000	80	31
140	105	40	105783 <sup>2)</sup> ●	105799 ●	105789 ▲	105805 ▲	3700	90	40
160	125	42	100300 ●	100325 ●	100322 ●	100754 ▲	3600	110	47
200	160	55	100000 ●	100465 ●	100014 ●	100483 ▲	3000	140	55
250	200	76	100200 ●	100834 ●	100221 ●	100840 ▲	2500	150	63
315	260	103	101248 ●	101567 ●	101254 ●	101900 ▲	2000	180	69
350	290	115	104132 <sup>2)</sup> ●	104868 ●	104135 ▲	104871 ▲	1700	210	74
400	330	136	102061 ●	102329 ●	102067 ●	102335 ▲	1600	240	92
500	420	190	106753 ●	102954 ▲	102537 ▲	102960 ▲	1000	260	100
630	545	240	102719 ●	102855 ▲	102725 ▲	102861 ▲	800	280	105
700	610	310	-	-	147500 ▲	147514 ▲	650	280	105
800	710	380	-	-	104626 ▲	104909 ▲	600	300	110
1000	910	460	-	-	104648 ▲	104921 ▲	480	450	115
1250	910	550	-	-	104650 ▲	104933 ▲	380	450	115

<sup>1)</sup> with one set reversible jaws

<sup>2)</sup> intermediate size

Tool group A09  
Geared scroll chucks ZG-ZGU  
mounting from front; cylindrical  
centre mount

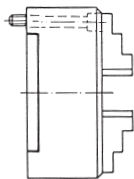

Size	ZA	Through-hole	3 jaw chuck with inside and outside jaw	4 jaw chuck with inside and outside jaw	Speed max. min <sup>-1</sup>	Torque Nm	Total clamping force kN
125	95	32	116304 ●	103053 ●	4000	80	31
160	125	42	115566 ●	115570 ●	3600	110	47
200	160	55	109127 ●	111339 ●	3000	140	55
250	200	76	114301 ●	127916 ●	2500	150	63
315	260	103	109128 ●	120743 ●	2000	180	69
400	330	136	123474 ●	146263 ▲	1600	240	92
500	420	190	117327 ●	129858 ▲	1000	260	100
630	545	240	111346 ▲	137545 ▲	800	280	105



## Economy - ZG-ZGU

Tool group A09  
Geared scroll chucks ZG-ZGU  
ISO 702-3 (DIN 55027); with studs  
and locknuts, optional DIN 55021  
with set screw and nut

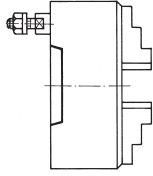

Size	Mount short taper	Through-hole	3 jaw chuck with inside and outside jaw	4 jaw chuck with inside and outside jaw	3 jaw chuck with base and reversible top jaw	4 jaw chuck with base and reversible top jaw	Speed max. min <sup>-1</sup>	Torque Nm	Total clamping force kN
100	3	20	102105 ▲	102153 ▲	102111 ▲	102159 ▲	4500	60	27
125	3	32	101644 ▲	107006 ▲	101647 ▲	107012 ▲	4000	80	31
125	4	32	101648 ■	107014 ▲	101651 ▲	107020 ▲	4000	80	31
140	3	40	105236 ■	105249 ▲	105522 ▲	105539 ▲	3700	90	40
140	4	40	105237 ▲	105250 ▲	105523 ▲	105540 ▲	3700	90	40
140	5	40	105238 ▲	105251 ▲	105524 ▲	105541 ▲	3700	90	40
160	3	42	105012 ▲	105052 ▲	105015 ▲	105055 ▲	3600	110	47
160	4	42	100358 ■	101109 ■	100361 ▲	101112 ▲	3600	110	47
160	5	42	100362 ●	101113 ■	100366 ▲	101116 ▲	3600	110	47
200	3	51,2	100053 ▲	101429 ▲	100056 ▲	101435 ▲	3000	140	55
200	4	55	100057 ▲	101437 ▲	100060 ▲	101443 ▲	3000	140	55
200	5	55	100045 ■	100471 ■	100051 ▲	101419 ▲	3000	140	55
200	6	55	100047 ■	101421 ■	100052 ▲	101427 ▲	3000	140	55
250	4	60,7	123120 ▲	123122 ▲	127868 ▲	127876 ▲	2500	150	63
250	5	76	100241 ▲	100856 ▲	100250 ▲	100865 ▲	2500	150	63
250	6	76	100239 ●	100854 ■	100248 ▲	100863 ▲	2500	150	63
250	8	76	100240 ■	100855 ■	100249 ▲	100864 ▲	2500	150	63
315	5	79,6	111195 ▲	118915 ▲	127869 ▲	127877 ▲	2000	180	69
315	6	103	101268 ■	101585 ■	101277 ▲	101594 ▲	2000	180	69
315	8	103	101269 ■	101586 ■	101278 ▲	101595 ▲	2000	180	69
315	11	103	101270 ▲	101587 ▲	101279 ▲	101596 ▲	2000	180	69
350	6	103	104156 ▲	104892 ▲	104159 ▲	104895 ▲	1700	210	74
350	8	115	104148 ▲	104884 ▲	104151 ▲	104887 ▲	1700	210	74
350	11	115	104152 ▲	104888 ▲	104155 ▲	104891 ▲	1700	210	74
400	6	103	102217 ▲	101891 ▲	102223 ▲	101897 ▲	1600	240	92
400	8	136	102201 ■	101875 ▲	102207 ▲	101881 ▲	1600	240	92
400	11	136	102209 ■	101883 ▲	102215 ▲	101889 ▲	1600	240	92
500	8	136	109734 ▲	105630 ▲	109737 ▲	105633 ▲	1000	260	100
500	11	190	102547 ▲	102970 ▲	102553 ▲	102976 ▲	1000	260	100
500	15	190	102914 ▲	103226 ▲	102920 ▲	103232 ▲	1000	260	100
630	11	192,7	102751 ▲	102887 ▲	102757 ▲	102893 ▲	800	280	105
630	15	240	102759 ▲	103083 ▲	102765 ▲	103089 ▲	800	280	105
700	11	192,7	-	-	147502 ▲	147516 ▲	650	280	105
700	15	281,2	-	-	147504 ▲	147518 ▲	650	280	105
800	11	192,7	-	-	126908 ▲	127266 ▲	600	300	110
800	15	281,2	-	-	129291 ▲	129323 ▲	600	300	110
800	20	380	-	-	129292 ▲	129324 ▲	600	300	110
1000	15	281,2	-	-	129293 ▲	129325 ▲	480	450	115
1000	20	407,5	-	-	129294 ▲	129326 ▲	480	450	115
1250	15	281,2	-	-	129295 ▲	129327 ▲	380	450	115
1250	20	407,5	-	-	129296 ▲	129328 ▲	380	450	115

Tool group A09  
Geared scroll chucks ZG-ZGU  
ISO 702-1 (DIN 55026); DIN 55021,  
ASA B 5.9, A1/A2 metr.; mounting  
from front

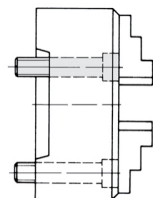

Size	Mount short taper	Through-hole	3 jaw chuck with inside and outside jaw	4 jaw chuck with inside and outside jaw	3 jaw chuck with base and reversible top jaw	4 jaw chuck with base and reversible top jaw	Speed max. min <sup>-1</sup>	Torque Nm	Total clamping force kN
160	5	42	100371 <sup>1)</sup> ■	101121 ▲	100376 ▲	101124 ▲	3600	110	47
200	5	42	100061 <sup>1)</sup> ■	101445 ▲	100066 ▲	101451 ▲	3000	140	55
200	6	55	100067 <sup>1)</sup> ▲	101453 ▲	100071 ▲	101459 ▲	3000	140	55
250	5	76	100257 ■	100868 ▲	100268 ▲	100877 ▲	2500	150	63
250	6	55	100251 <sup>1)</sup> ■	100866 ▲	100266 ▲	100875 ▲	2500	150	63
250	8	76	100254 <sup>1)</sup> ▲	100867 ▲	100267 ▲	100876 ▲	2500	150	63
315	6	103	101280 ■	101597 ▲	101289 ▲	101936 ▲	2000	180	69
315	8	76	101281 <sup>1)</sup> ▲	101938 ▲	101290 ▲	101944 ▲	2000	180	69
350	6	103	114642 ▲	114644 ▲	127810 ▲	127846 ▲	1700	210	74
350	8	76	116659 <sup>1)</sup> ▲	117057 ▲	127803 ▲	127845 ▲	1700	210	74
400	8	136	102225 ▲	103322 ▲	102231 ▲	102358 ▲	1600	240	92
400	11	125	102233 <sup>1)</sup> ▲	102360 ▲	102239 ▲	102366 ▲	1600	240	92
500	11	190	102561 ▲	102978 ▲	102567 ▲	102984 ▲	1000	260	100
630	11	190	102767 ▲	102895 ▲	102773 ▲	103001 ▲	800	280	105
630	15	190	102783 <sup>1)</sup> ▲	103011 ▲	102789 ▲	103017 ▲	800	280	105
700	11	193	-	-	147506 ▲	147520 ▲	650	280	105
700	15	281,2	-	-	147508 ▲	147522 ▲	650	280	105
800	11	193	-	-	126909 ▲	127269 ▲	600	300	110
800	15	281,2	-	-	129299 ▲	129331 ▲	600	300	110
800	20	380	-	-	129300 ▲	129332 ▲	600	300	110
1000	15	281,2	-	-	129301 ▲	129333 ▲	480	450	115
1000	20	407,5	-	-	129302 ▲	129334 ▲	480	450	115
1250	15	281,2	-	-	129303 ▲	129335 ▲	380	450	115
1250	20	407,5	-	-	129304 ▲	129336 ▲	380	450	115

<sup>1)</sup> mounting from front in the inner bolt circle

## Economy - ZG-ZGU

Tool group A09  
Geared scroll chucks ZG-ZGU  
ISO 702-2 (DIN 55029); ASA B 5.9,  
Type D, with studs for Camlock

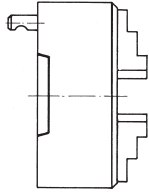

Size	Mount short taper	Through-hole	3 jaw chuck with inside and outside jaw	4 jaw chuck with inside and outside jaw	3 jaw chuck with base and reversible top jaw	4 jaw chuck with base and reversible top jaw	Speed max. min <sup>-1</sup>	Torque Nm	Total clamping force kN
100	3	20	108677 ▲	109017 ▲	105842 ▲	105844 ▲	4500	60	27
125	3	32	108678 ●	109172 ▲	105850 ▲	105854 ▲	4000	80	31
125	4	32	108682 ▲	109176 ▲	105866 ▲	105868 ▲	4000	80	31
140	3	40	108679 ▲	109173 ▲	-	-	3700	90	40
140	4	40	108683 ●	109177 ▲	-	-	3700	90	40
140	5	40	108686 ▲	109180 ▲	-	-	3700	90	40
160	3	42	108680 ▲	-	106306 ▲	-	3600	110	47
160	4	42	108684 ●	109178 ●	105874 ▲	105878 ▲	3600	110	47
160	5	42	108687 ●	109181 ▲	105890 ▲	105894 ▲	3600	110	47
200	3	51,2	108681 ▲	109175 ▲	106354 ▲	106358 ▲	3000	140	55
200	4	55	108685 ●	109179 ●	106370 ▲	106372 ▲	3000	140	55
200	5	55	108688 ●	109182 ●	106322 ▲	106326 ▲	3000	140	55
200	6	55	108691 ●	109185 ●	106338 ▲	106342 ▲	3000	140	55
250	4	60,7	127860 ▲	127864 ▲	127872 ▲	127882 ▲	2500	150	63
250	5	76	108689 ●	109183 ▲	106410 ▲	106414 ▲	2500	150	63
250	6	76	108692 ●	109186 ●	106378 ▲	106382 ▲	2500	150	63
250	8	76	108696 ▲	109190 ▲	106394 ▲	106398 ▲	2500	150	63
315	5	79,6	124918 ▲	127865 ▲	127873 ▲	127883 ▲	2000	180	69
315	6	103	108693 ▲	109187 ▲	106434 ▲	106438 ▲	2000	180	69
315	8	103	108697 ●	109191 ▲	106450 ▲	106454 ▲	2000	180	69
315	11	103	108883 ●	109196 ▲	106466 ▲	106470 ▲	2000	180	69
350	6	103	108695 ▲	109189 ▲	106698 ▲	106802 ▲	1700	210	74
350	8	115	108699 ▲	109193 ▲	106666 ▲	106670 ▲	1700	210	74
350	11	115	108887 ▲	109200 ▲	106682 ▲	106686 ▲	1700	210	74
400	6	103	108694 ▲	109188 ▲	106622 ▲	106626 ▲	1600	240	92
400	8	136	108698 ▲	109192 ▲	106490 ▲	106494 ▲	1600	240	92
400	11	136	108884 ▲	109197 ▲	106606 ▲	106610 ▲	1600	240	92
500	8	136	108834 ▲	109194 ▲	104404 ▲	105651 ▲	1000	260	100
500	11	190	108885 ▲	109198 ▲	106638 ▲	106642 ▲	1000	260	100
500	15	190	108888 ▲	109201 ▲	104426 ▲	104428 ▲	1000	260	100
630	11	192,7	108886 ▲	109199 ▲	106650 ▲	106654 ▲	800	280	105
630	15	240	108889 ▲	109202 ▲	103324 ▲	104492 ▲	800	280	105
700	11	192,7	-	-	147510 ▲	147524 ▲	650	280	105
700	15	281,2	-	-	147512 ▲	147526 ▲	650	280	105
800	11	192,7	-	-	126911 ▲	127273 ▲	600	300	110
800	15	281,2	-	-	129307 ▲	129315 ▲	600	300	110
800	20	380	-	-	129308 ▲	129316 ▲	600	300	110
1000	15	281,2	-	-	129309 ▲	129317 ▲	480	450	115
1000	20	407,5	-	-	129310 ▲	129318 ▲	480	450	115
1250	15	281,2	-	-	129311 ▲	129319 ▲	380	450	115
1250	20	407,5	-	-	129312 ▲	129320 ▲	380	450	115

Tool group A09  
Type 300 ZG with base plate  
3-jaw-chuck cast iron body

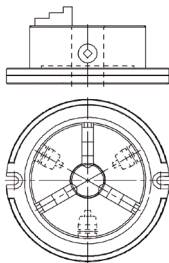

Size	Through-hole	3 jaw chuck with inside and outside jaw	Torque Nm	Total clamping force kN
160	42	127857 ●	110	47
200	55	127858 ●	140	55
250	76	127859 ●	150	63
315	103	150594 ●	180	69

## Jaws ZS-ZSU / ZG-ZGU

Tool group A09  
Type 300 **Inside jaw BB DIN 6350**  
outward stepped jaw, hardened

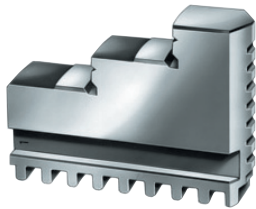

Chuck Size	3-jaw set	4-jaw set	Jaw length	Jaw height	Jaw width
74	110154 <sup>1)</sup> ●	149305 <sup>1)</sup> ■	32	23	10
80/85	110155 ●	110063 ■	37	26	12
100/110	110156 ●	110064 ■	48	33,5	14
125	110157 ●	110065 ●	52	41,5	18
140	110158 ●	110066 ■	61	41,5	18
160	110159 ●	110067 ●	61	47,5	18
200	110160 ●	110068 ●	69	53,5	20
250	110161 ●	110069 ●	90	67,5	24
315	110162 ●	110070 ●	130	79,5	34
350/400	110163 ●	110071 ■	130	79,5	34
500/630	110164 ■	110072 ■	190	95	42

<sup>1)</sup> reversible, for use as turning or inside jaws

Stepped and hardened jaws, supplied as supplement or as spares, must be ground on the chuck.  
In case of a subsequent jaw delivery please return the chuck.

Tool group A09  
Type 300 **Outside jaw DB DIN 6350**  
inward stepped jaw, hardened

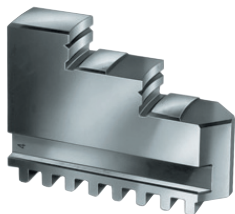

Chuck Size	3-jaw set	4-jaw set	Jaw length	Jaw height	Jaw width
80/85	110165 ●	110073 ■	37	26	12
100/110	110166 ●	110074 ■	48	33,5	14
125	110167 ●	110075 ●	52	41,5	18
140	110168 ●	110076 ■	61	41,5	18
160	110169 ●	110077 ●	61	47,5	18
200	110170 ●	110078 ●	69	53,5	20
250	110171 ●	110079 ●	90	67,5	24
315	110016 ●	110080 ■	130	79,5	34
350/400	110017 ●	110081 ■	130	79,5	34
500/630	110018 ■	110082 ■	190	95	42

Stepped and hardened jaws, supplied as supplement or as spares, must be ground on the chuck.  
In case of a subsequent jaw delivery please return the chuck.

Tool group A09  
Type 301 **Unstepped jaw BL DIN 6350**  
unstepped, soft, 16MnCr5  
suitable for ZG-ZS, ZGU-ZSU,  
ZG Hi-Tru



Chuck Size	3-jaw set	4-jaw set	Jaw length	Jaw height	Jaw width
74	109114 <sup>1)</sup> ●	149304 ■	32	23	10
80/85	107588 ●	107598 ●	37	26	12
100/110	107589 ●	107599 ●	48	33,5	14
125	107590 ●	107600 ●	52	41,5	18
140	107591 ●	107601 ●	61	41,5	18
160	107592 ●	107602 ●	61	47,5	18
200	107593 ●	107603 ●	69	53,5	20
250	107594 ●	107604 ●	90	67,5	24
315	107595 ●	107605 ●	130	79,5	34
350/400	107596 ●	107644 ●	130	79,5	34
500/630	107597 ●	107645 ■	190	95	42

<sup>1)</sup> jaws reversible

Tool group A09  
Type 302 **Base jaw GB DIN 6350**  
with fixing screw

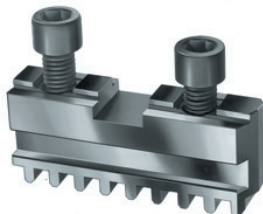

Chuck Size	3-jaw set	4-jaw set	Jaw length	Jaw width
100/110	107500 ●	107542 ●	46	14
125	107501 ●	107543 ●	55	18
140	107502 ●	107544 ■	65	18
160	107503 ●	107545 ●	65	18
200	107504 ●	107546 ●	78	20
250	107505 ●	107547 ●	92	24
315	107506 ●	107548 ●	108	34
350/400	107507 ●	107549 ■	127	34
500	107508 ●	107550 ■	165	42
630	107509 ●	107551 ■	203	42
700	115098 ■	141621 ■	253	55
800	105272 ■	141616 ■	291	55
1000	105274 ▲	141611 ▲	329	55
1250	105275 ▲	141614 ▲	367	55

# Jaws ZS-ZSU / ZG-ZGU

Tool group A09  
Type 303 **Reversible top jaws UB**  
**DIN 6350**  
hardened

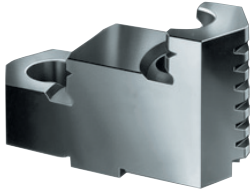

Chuck Size	3-jaw set	4-jaw set	Jaw length	Jaw height	Jaw width
100/110	108045 ■	108053 ■	47	29,5	22
125	108046 ■	108054 ■	56	37,5	26
140/160	107936 ●	107938 ■	66,7	41,5	28
200	107937 ●	107939 ■	79,5	42,5	30
250	108049 ●	108057 ■	95,3	52,5	36
315	108050 ●	108058 ■	109,5	57,5	42
350/400	108051 ●	108059 ■	127	64,5	42
500/630	108052 ■	108060 ■	127	79,5	50
700/800	105081 ■	105085 ■	210	89	68
1000/1250	105098 ■	105101 ■	210	110	68

Stepped and hardened jaws, supplied as supplement or as spares, must be ground on the chuck.  
In case of a subsequent jaw delivery please return the chuck.

Tool group A09  
Type 302 **Unstepped top jaw AB**  
**DIN 6350**  
soft, material 16MnCr5



Chuck Size	3-jaw set	4-jaw set	Jaw length	Jaw height	Jaw width
100/110	107633 ●	107641 ■	53	30	22,5
125	107634 ●	107642 ●	62	38	26,5
140/160	108581 ●	108583 ●	74	42	28,5
200	108582 ●	108584 ●	87	43	30,5
250	107637 ●	107579 ●	103	53	36,5
315	107638 ●	107580 ●	120	58	42,5
350/400	107639 ●	107581 ●	137	65	42,5
500/630	107640 ●	107582 ●	140	80	50,5
700/800	105103 ■	105105 ■	210	89	68
1000/1250	105107 ●	105109 ■	210	110	68

Tool group A09  
Type 301 **Unstepped jaw BL**,  
**special length**, soft, 16MnCr5  
**DIN 6350**

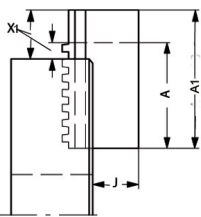
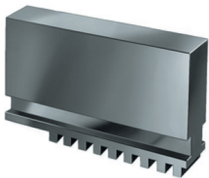

Chuck Size	3-jaw set	4-jaw set	A1	X1 max.	A	J	X máx.
200	130031 ■	137073 ■	100	50	69	32,5	19
250	132658 ■	137074 ■	120	56	90	41	26
315	132184 ■	129894 ■	160	70	130	46	40
350/400	137075 ■	130442 ■	160	70	130	42	40
500/630	131540 ■	137076 ■	220	80	190	55	50
200	130033 ■	137077 ■	120	70	69	32,5	19
250	128880 ■	130610 ■	140	76	90	41	26
315	118908 ■	137078 ■	200	110	130	46	40
350/400	137079 ■	137080 ■	200	110	130	42	40
500/630	137081 ■	137082 ■	280	140	190	55	50
315	121367 ■	133691 ■	250	160	130	46	40
350/400	137087 ■	137088 ■	250	160	130	42	40

Tool group A09  
Type 301 **Unstepped jaw BL**,  
**special height**, soft, 16MnCr5  
**DIN 6350**

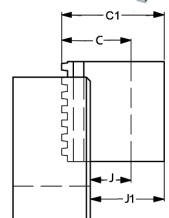

Chuck Size	3-jaw set	4-jaw set	C1	J1	C	J
200	125710 ■	132972 ■	80	58,5	54	32,5
250	122188 ■	134796 ■	100	73	68	41
315	132186 ■	137091 ■	110	76	80	46
350/400	137092 ■	131655 ■	110	72	80	42
500/630	137093 ■	137094 ■	150	110	95	55
200	125712 ■	137095 ■	120	98,5	54	32,5
250	122189 ■	130630 ■	130	103	68	41
315	137096 ■	137097 ■	140	106	80	46
350/400	137098 ■	137099 ■	140	102	80	42
500/630	125117 ■	137100 ■	200	160	95	55
200	125714 ■	137101 ■	150	128,5	54	32,5
250	137102 ■	137103 ■	150	123	68	41
315	137104 ■	130340 ■	160	126	80	46
350/400	132879 ■	110109 ■	160	122	80	42



# Jaws ZS-ZSU / ZG-ZGU

Tool group A09  
Type 302 **Top jaw AB, special length**, soft, 16MnCr5  
DIN 6350

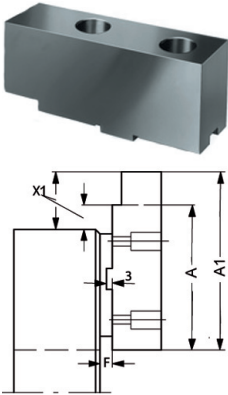

Chuck Size	3-jaw set	4-jaw set	A1	X1 max.	F	A	X max.
200	110086	148139	100	43	6,8	87	30
250	112122	129289	130	63	8	103	36
315	110624	143764	160	76	5,5	120	36
350/400	110626	141277	160	53	8,5	137	30
500/630	103014	103393	170	75	8,5	140	45
200	112120	148657	120	63	6,8	87	30
250	125428	128700	150	83	8	103	36
315	112091	147754	200	116	5,5	120	36
350/400	112118	141263	200	93	8,5	137	30
500/630	110632	148234	220	125	8,5	140	45
250	104710	146013	180	113	8	103	36
315	112089	147860	250	166	5,5	120	36
350/400	103654	149974	260	153	8,5	137	30
500/630	112127	148235	280	185	8,5	140	45

Tool group A09  
Type 302 **Top jaw AB, special height**, soft, 16MnCr5  
DIN 6350

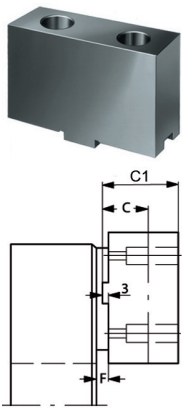

Chuck Size	3-jaw set	4-jaw set	C1	C	F
200	132155	132181	60	43	6,8
250	119645	135867	70	53	8
315	110435	149975	80	58	5,5
350/400	126385	118373	90	65	8,5
500/630	128590	149985	100	80	8,5
200	128564	149976	80	43	6,8
250	128571	134999	100	53	8
315	110437	129691	110	58	5,5
350/400	110628	135426	120	65	8,5
500/630	110630	149977	130	80	8,5
250	128573	149978	150	53	8
315	128569	141671	150	58	5,5
350/400	128567	139591	160	65	8,5
500/630	128588	140427	160	80	8,5

Tool group A09  
Type 302 **Top jaw AB, special width and height**, soft, 16MnCr5  
DIN 6350

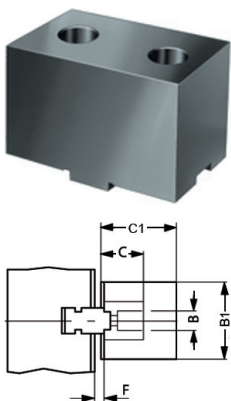

Chuck Size	3-jaw set	4-jaw set	B1	C1	B	C
200	105057	105061	40	70	30.5	43
250	137090	141338	50	80	36.5	53
315	143053	149979	60	90	42	58
350/400	131567	149980	60	90	42.5	65
500/630	137084	149981	80	110	50.5	80
200	133259	149982	50	80	30.5	43
250	133653	137526	60	90	36.5	53
315	143057	149983	80	110	42	58
350/400	137086	149984	80	110	42.5	65

Tool group C15  
Type 0040-Y **Mounting bolt for top jaws bolt 1**

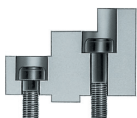

Item no.	Size	Thread
249299	100/110	M6x20
236949	125	M8x25
334571	140/160/200	M8x30
233025	250	M12x40
233026	315	M12x45
220565	350/400	M16x50
249003	500/630	M20x80

Tool group C15  
Type 0040-Y **Mounting bolt for top jaws bolt 2**



Item no.	Size	Thread
216528	100/110	M6x16
233058	125/140/160/200	M8x20
227692	250	M12x25
233030	315	M12x30
220564	350/400	M16x35
233047	500/630	M20x40

# Accessories ZS-ZSU / ZG-ZGU

Tool group A09

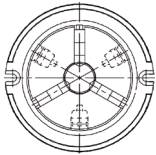
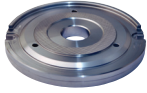
**Type 600 Base plates** for lathe chucks with **cylindrical centre mount** DIN 6350

Item no.	Size
162793 <span style="color: yellow;">■</span>	160
162401 <span style="color: yellow;">■</span>	200
163036 <span style="color: yellow;">■</span>	250
133705 <span style="color: yellow;">■</span>	315

Tool group A09

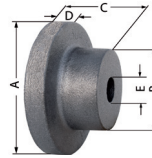
**Type 304 Unfinished adapter plates** for **cylindrical mount**  
 The unfinished back plate must be machined and fitted on both machine and chuck side

Item no.	Chuck Size	Inch	A	B	C	D	E
017123 <span style="color: yellow;">■</span>	74	3	80	56	45	15	-
017113 <span style="color: green;">●</span>	80	3 ¼	92	56	47	15	20
017114 <span style="color: green;">●</span>	100	4	120	80	58	20	25
017115 <span style="color: green;">●</span>	125	5	135	80	58	20	25
017125 <span style="color: yellow;">■</span>	140	5 ½	150	80	58	20	25
017116 <span style="color: green;">●</span>	160	6 ¼	170	80	58	20	30
017117 <span style="color: green;">●</span>	200	8	210	92	66	22	40
017118 <span style="color: yellow;">■</span>	250	10	260	105	92	25	50
017119 <span style="color: yellow;">■</span>	315	12 ½	330	165	100	30	50
017124 <span style="color: yellow;">■</span>	350	14	365	180	120	30	60

Tool group A09

**Type 300 Chip guard, piece**

Item no.	Contents of delivery	Size
108500 <span style="color: yellow;">■</span>	piece	80/85
108501 <span style="color: green;">●</span>	piece	100/110
108502 <span style="color: green;">●</span>	piece	125
108503 <span style="color: green;">●</span>	piece	140/160
108504 <span style="color: green;">●</span>	piece	200
108505 <span style="color: green;">●</span>	piece	250
108506 <span style="color: green;">●</span>	piece	315/350/400
108508 <span style="color: green;">●</span>	piece	500/630

Tool group A09

**Type 1028 Special grease F80** for lathe chucks  
 for lubrication and conservation of chucking power

Item no.	Design	Contents
028975 <span style="color: green;">●</span>	Tin	1 kg

Tool group A09

**Type 300 Scroll**

Item no.	Size
102521 <span style="color: green;">●</span>	74
102183 <span style="color: green;">●</span>	80/85
101754 <span style="color: green;">●</span>	100
112660 <span style="color: green;">●</span>	110
101721 <span style="color: green;">●</span>	125
105827 <span style="color: green;">●</span>	140
100303 <span style="color: green;">●</span>	160
100003 <span style="color: green;">●</span>	200
100203 <span style="color: green;">●</span>	250
101552 <span style="color: green;">●</span>	315
105228 <span style="color: yellow;">■</span>	350
102497 <span style="color: green;">●</span>	400
162973 <span style="color: yellow;">■</span>	500
162964 <span style="color: yellow;">■</span>	630

Tool group A09

**Type 300 Driving pinion**

Item no.	Size
102522 <span style="color: yellow;">■</span>	74
102184 <span style="color: green;">●</span>	80
113198 <span style="color: yellow;">■</span>	85
101755 <span style="color: green;">●</span>	100
112662 <span style="color: green;">●</span>	110
101722 <span style="color: green;">●</span>	125
105828 <span style="color: green;">●</span>	140
100304 <span style="color: green;">●</span>	160
100005 <span style="color: green;">●</span>	200
100204 <span style="color: green;">●</span>	250
112267 <span style="color: yellow;">■</span>	270
101553 <span style="color: green;">●</span>	315
105229 <span style="color: green;">●</span>	350
102498 <span style="color: green;">●</span>	400
162974 <span style="color: yellow;">■</span>	500
162965 <span style="color: yellow;">■</span>	630

Tool group A09

**Type 300 Pinion holder screw**

Item no.	Size
102523 <span style="color: yellow;">■</span>	74
102185 <span style="color: green;">●</span>	85
100305 <span style="color: green;">●</span>	160
100006 <span style="color: green;">●</span>	270
101554 <span style="color: green;">●</span>	315
102499 <span style="color: green;">●</span>	400
103300 <span style="color: green;">●</span>	630

Tool group A09

**Type 300 Standard key**

Item no.	Size	Square	Hexagon	Length
006325 <span style="color: green;">●</span>	74	-	6	55
107426 <span style="color: green;">●</span>	80/85	6	-	62
107427 <span style="color: green;">●</span>	100/110	8	-	75
107428 <span style="color: green;">●</span>	125/140	9	-	80
107429 <span style="color: green;">●</span>	160	10	-	90
107430 <span style="color: green;">●</span>	200/230	11	-	100
107431 <span style="color: green;">●</span>	250/270	12	-	100
107432 <span style="color: green;">●</span>	315	14	-	110
107433 <span style="color: green;">●</span>	350	14	-	140
107434 <span style="color: green;">●</span>	400	17	-	140
107435 <span style="color: green;">●</span>	500/630	19	-	150

# Accessories ZS-ZSU / ZG-ZGU

Tool group A09

 Type 300 **Safety key with ejector**

Item no.	Size	Square	Length
154370	80/85	6	110
154371	100/110	8	130
154372	125/140	9	130
154373	160	10	160
154374	200/230	11	160
154375	250/270	12	160
154376	315	14	200
154377	350	14	200
154378	400	17	250
154379	500/630	19	250

Tool group A09

 Type 300 **Elongated safety key with ejector**

Item no.	Size	Square	Length
154683	125/140	9	170
154685	160	10	180
154687	200/230	11	200
154689	250/270	12	200
154695	315	14	250

Tool group A09

 Type 300 **Safety key with ejector**  
for actuating the chuck with torque (defined torque introduction)

Item no.	Size	Square	Inch
178566	80/85	6	1/2
178567	100/110	8	1/2
178568	125/140	9	1/2
178569	160	10	1/2
178570	200/230	11	1/2
178571	250/270	12	1/2
178572	315/350	14	1/2
178573	400	17	1/2
178574	500/630/700/800	19	3/4
178575	1000/1250	24	3/4

Tool group A09

 Type 0040-Y **Mounting screws**  
with **cylindrical centre rim**

Item no.	Size	Thread
249299	74-85	M6x20
334571	100-140	M8x30
249301	160-230	M10x35
233025	250-270	M12x40
220565	315-350	M16x50
229183	400-630	M16x60

Tool group C15

 Type 0040-Y **Mounting screws**  
for lathe chucks with **direct short-taper**,  
for **front mounting**

Item no.	Size	Thread	Chuck Size	Taper size
302195	74	M10x55	160	5
200184	80	M10x65	200	5
233006	85	M12x65	200	6
233075	100	M10x90	250	5
216549	110	M12x70	250	6
302194	125	M16x70	250	8
242954	140	M12x100	315	6
358816	160	M16x85	315	8
243665	200/230	M12x130	350	6
236516	315	M16x110	400	8
615744	350	M20x95	400	11
010210	400	M20x130	500	11
328925	500	M20x145	630	11
367648	630	M24x125	630	15

Tool group C15

 Type 310 **Set screw with nut DIN 55021**

Item no.	Thread	For taper	Quantity
107453	M10x30	4	3
107455	M10x35	5	4
107456	M12x40	6	4
107457	M16x45	8	4
107458	M20x55	11	6
127618	M24x65	15	6

Tool group A09

 Type 330 **Stud for Camlock ASA B 5.9 (DIN 55029) and cylindrical studs**

Item no.	Thread	For taper	Quantity
107465	7/16-20x35	3	3
107466	7/16-20x37	4	3
107467	½-20x43	5	6
107468	5/8-18x49	6	6
107469	¾-16x55,5	8	6
107470	7/8-14x67	11	6
127621	1-14x76	15	6
130637	1½-12x89	20	6

Tool group A09

 Type 315 **Stud and locknut ISO 702-3 (DIN 55027)**

Item no.	Contents of delivery	Thread	For taper	Quantity
107447	piece	M10x34	3	3
107448	piece	M10x39	4	3
107449	piece	M10x43	5	4
107450	piece	M12x50	6	4
107451	piece	M16x60	8	4
107452	piece	M20x75	11	6
125650	piece	M24x90	15	6
130636	piece	M24x100	20	6

Tool group A09

 Type 315 **Stud and locknut ISO 702-3 (DIN 55027)**

Item no.	Thread	For taper	Quantity
107447	M10x34	3	3
107448	M10x39	4	3
107449	M10x43	5	4
107450	M12x50	6	4
107451	M16x60	8	4
107452	M20x75	11	6
125650	M24x90	15	6
130636	M24x100	20	6

## Economy - ZGF



Suitable for use on ground and basic plates.

### Technical features:

- with scroll
- unstepped soft top jaw
- cast iron body
- DIN 6350
- DIN 6350
- lathe chucks must be lubricated regularly to maintain their gripping force
- further sizes on request

### Delivery includes:

- 1 set of base jaws
- 1 set of top jaws soft
- 1 operating key
- mounting bolts

Tool group A09  
Type 152, **2-jaw cast iron body**,  
unstepped top jaws  
**DIN 6350**; cylindrical centre mount,  
form A

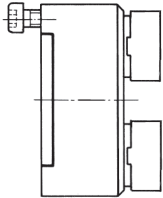

Item no.	Size	Through-hole	Speed max. min <sup>-1</sup>	Torque Nm	Total clamping force kN
105934 ■	100	20	2700	60	27
105935 ■	125	32	2400	80	31
105937 ■	160	42	2200	110	47
105938 ■	200	55	1800	140	55
105939 ■	250	76	1500	150	63
105940 ▲	315	103	1200	180	69
108459 ▲	350	115	1000	210	74
105941 ▲	400	136	950	240	92

chucks with short-taper mount on request

Tool group A09  
Type 152, **2-jaw cast iron body**,  
unstepped top jaws  
**mounting from front**; cylindrical  
centre mount

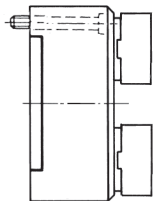

Item no.	Size	Through-hole	Speed max. min <sup>-1</sup>	Torque Nm	Total clamping force kN
142426 ▲	125	32	2400	80	31
142469 ▲	160	42	2200	110	47
148230 ▲	200	55	1800	140	55
116353 ▲	250	76	1500	150	63
144892 ▲	315	103	1200	180	69
149720 ▲	400	136	950	240	92

chucks with short-taper mount on request



## Jaws ZGF

Tool group A09  
Type 152 **Base jaw GB** DIN 6350  
with fixing screw

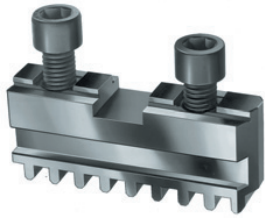

Item no.	Chuck Size	Number of jaws	Jaw length	Jaw width
108950 ■	100	2	46	14
108951 ■	125	2	55	18
108953 ■	160	2	65	18
108954 ■	200	2	78	20
108955 ■	250	2	92	24
108956 ■	315	2	108	34
108957 ■	350/400	2	127	34

Tool group A09  
Type 152 **Unstepped top jaw AB**  
**DIN 6350**  
soft, material 16MnCr5



Item no.	Chuck Size	Number of jaws	Jaw length	Jaw height	Jaw width
109497 ■	100	2	53	30	22,5
109498 ■	125	2	62	38	26,5
109499 ■	160	2	74	42	28,5
109501 ■	200	2	87	43	30,5
109502 ■	250	2	103	53	36,5
109503 ■	315	2	120	58	42,5
109504 ■	350/400	2	137	65	42,5

Tool group C15  
Type 0040-Y **Mounting bolt for top jaws bolt 2**



Item no.	Contents of delivery	Size	Thread
216528 ●	piece	100/110	M6x16
233058 ●	piece	125/140/160/200	M8x20
227692 ●	piece	250	M12x25
233030 ●	piece	315	M12x30
220564 ●	piece	350/400	M16x35

## Accessories ZGF

Tool group A09

Type 600 **Base plates** for lathe chucks with **cylindrical centre mount DIN 6350**

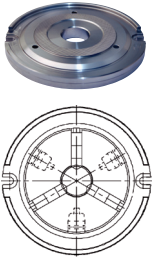

Item no.	Size
162793 <span style="color: yellow;">■</span>	160
162401 <span style="color: yellow;">■</span>	200
163036 <span style="color: yellow;">■</span>	250
133705 <span style="color: yellow;">■</span>	315

Tool group A09

Type 304 **Unfinished adapter plates for cylindrical mount** The unfinished back plate must be machined and fitted on both machine and chuck side

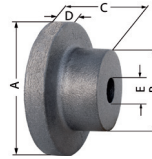

Item no.	Chuck Size	Inch	A	B	C	D	E
017114 <span style="color: green;">●</span>	100	4	120	80	58	20	25
017115 <span style="color: green;">●</span>	125	5	135	80	58	20	25
017116 <span style="color: green;">●</span>	160	6 ¼	170	80	58	20	30
017117 <span style="color: green;">●</span>	200	8	210	92	66	22	40
017118 <span style="color: yellow;">■</span>	250	10	260	105	92	25	50
017119 <span style="color: yellow;">■</span>	315	12 ½	330	165	100	30	50
017124 <span style="color: yellow;">■</span>	350	14	365	180	120	30	60

Tool group A09

Type 300 **Chip guard, piece**



Item no.	Contents of delivery	Size
108501 <span style="color: green;">●</span>	piece	100/110
108502 <span style="color: green;">●</span>	piece	125
108503 <span style="color: green;">●</span>	piece	140/160
108504 <span style="color: green;">●</span>	piece	200
108505 <span style="color: green;">●</span>	piece	250
108506 <span style="color: green;">●</span>	piece	315/350/400

Tool group A09

Type 1028 **Special grease F80 for lathe chucks** for lubrication and conservation of chucking power



Item no.	Design	Contents
028975 <span style="color: green;">●</span>	Tin	1 kg

Tool group A09

Type 300 **Scroll**



Item no.	Size
101754 <span style="color: green;">●</span>	100
101721 <span style="color: green;">●</span>	125
100303 <span style="color: green;">●</span>	160
100003 <span style="color: green;">●</span>	200
100203 <span style="color: green;">●</span>	250
101552 <span style="color: green;">●</span>	315
105228 <span style="color: yellow;">■</span>	350
102497 <span style="color: green;">●</span>	400

Tool group A09

Type 300 **Driving pinion**



Item no.	Size	Hexagon
178473 <span style="color: green;">●</span>	100	9
178474 <span style="color: green;">●</span>	110	9
178475 <span style="color: green;">●</span>	125	10
178476 <span style="color: green;">●</span>	140	10
178477 <span style="color: green;">●</span>	160	11
178478 <span style="color: green;">●</span>	200	12
178479 <span style="color: yellow;">■</span>	230	12
178480 <span style="color: green;">●</span>	250	14
178481 <span style="color: yellow;">■</span>	270	14
178482 <span style="color: green;">●</span>	315	17
178483 <span style="color: green;">●</span>	400	19

Tool group A09

Type 300 **Pinion holder screw**



Item no.	Size
100305 <span style="color: green;">●</span>	160
100006 <span style="color: green;">●</span>	270
101554 <span style="color: green;">●</span>	315
102499 <span style="color: green;">●</span>	400

Tool group A09

Type 300 **Standard key**



Item no.	Size	Square	Length
107427 <span style="color: green;">●</span>	100/110	8	75
107428 <span style="color: green;">●</span>	125/140	9	80
107429 <span style="color: green;">●</span>	160	10	90
107430 <span style="color: green;">●</span>	200/230	11	100
107431 <span style="color: green;">●</span>	250/270	12	100
107432 <span style="color: green;">●</span>	315	14	110
107433 <span style="color: green;">●</span>	350	14	140
107434 <span style="color: green;">●</span>	400	17	140

Tool group A09

Type 300 **Safety key with ejector**



Item no.	Size	Square	Length
154371 <span style="color: green;">●</span>	100/110	8	130
154372 <span style="color: green;">●</span>	125/140	9	130
154373 <span style="color: green;">●</span>	160	10	160
154374 <span style="color: green;">●</span>	200/230	11	160
154375 <span style="color: green;">●</span>	250/270	12	160
154376 <span style="color: green;">●</span>	315	14	200
154377 <span style="color: green;">●</span>	350	14	200
154378 <span style="color: green;">●</span>	400	17	250

Tool group A09

Type 300 **Elongated safety key with ejector**



Item no.	Size	Square	Length
154683 <span style="color: green;">●</span>	125/140	9	170
154685 <span style="color: green;">●</span>	160	10	180
154687 <span style="color: green;">●</span>	200/230	11	200
154689 <span style="color: green;">●</span>	250/270	12	200
154695 <span style="color: green;">●</span>	315	14	250

Tool group A09

Type 300 **Safety key with ejector** for actuating the chuck with torque (defined torque introduction)



Item no.	Size	Square	Inch
178566 <span style="color: green;">●</span>	80/85	6	1/2
178567 <span style="color: green;">●</span>	100/110	8	1/2
178568 <span style="color: green;">●</span>	125/140	9	1/2
178569 <span style="color: green;">●</span>	160	10	1/2
178570 <span style="color: green;">●</span>	200/230	11	1/2
178571 <span style="color: green;">●</span>	250/270	12	1/2
178572 <span style="color: green;">●</span>	315/350	14	1/2

Tool group A09

Type 0040-Y **Mounting screws** with **cylindrical centre rim**



Item no.	Size	Thread
334571 <span style="color: green;">●</span>	100-140	M8x30
249301 <span style="color: green;">●</span>	160-230	M10x35
233025 <span style="color: green;">●</span>	250-270	M12x40
220565 <span style="color: green;">●</span>	315-350	M16x50
229183 <span style="color: green;">●</span>	400-630	M16x60

**Precision - ZG Hi-Tru**



The ZG Hi-Tru hand-operated lathe chuck is most suitable for the production of components with top concentricity. It is for universal use, but particularly profitable for grinding machines, dividing apparatus and turning machines.

Handling is very simple. The clamped workpiece is adjusted to the required concentricity by means of 3 tangentially arranged adjusting spindles. Self-centering with the aid of scroll and pinion.

**Technical features:**

- with one set outside jaws and one set inside jaws
- with scroll
- with radial precision adjustment for top concentricity
- self-centering
- hardened adjusting spindles
- hardened adjusting spindles
- lathe chucks must be lubricated regularly to maintain their gripping force

**Customer advantage:**

- adjusting accuracy within 0.005 mm
- repeatability 0.015 mm
- induction hardened support surface for adjusting spindle
- steel adapter plate
- cast iron body
- precision adjustment without opening the mounting screws

**Delivery includes (BB and DB):**

- 1 set of outward stepped jaws (BB) mounted in the chuck,
- 1 set of inward stepped jaws (DB),
- 1 operating key, mounting bolts

Tool group A09  
Type 306-00 **ZG Hi-Tru, with one set outward stepped jaws and one set inward stepped jaws**  
**DIN 6350**; cylindrical centre mount, form A

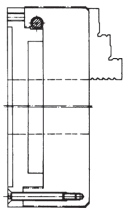

Item no.	Size	ZA	Through-hole	Speed max. min <sup>-1</sup>	Torque Nm	Total clamping force kN
146195 ■	80	56	19	5000	30	13
146196 ●	100	70	20	4500	60	27
145118 ●	125	95	32	4000	80	31
145119 ●	160	125	42	3600	110	47
144749 ●	200	160	55	3000	140	55
145120 ●	250	200	76	2500	150	63
143545 ■	315	260	103	2000	180	69

on request from size 125 with 6 jaws or with short-taper mount to ISO 702-3 (DIN 55027) or ISO 702-2 (DIN 55029) Camlock

Tool group A09  
Type 306-04 **ZG Hi-Tru, with special seal for grinding machines**  
**DIN 6350**; cylindrical centre mount, form A

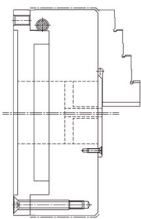

Item no.	Size	ZA	Speed max. min <sup>-1</sup>	Torque Nm	Total clamping force kN
146197 ■	80	56	5000	30	13
146198 ■	100	70	4500	60	27
144957 ■	125	95	4000	80	31
145116 ■	160	125	3600	110	47
145110 ■	200	160	3000	140	55
145117 ■	250	200	2500	150	63
146199 ■	315	260	2000	180	69

on request from size 125 with 6 jaws or with short-taper mount to ISO 702-3 (DIN 55027) or ISO 702-2 (DIN 55029) Camlock

**DIN 6350**  
**Dimensions ZG Hi-Tru**  
Cylindrical centre mount, Form A

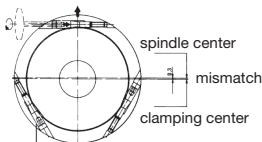

hexagon

Size A	Inch	B <sup>+0.02</sup>	C	D	F	G	SW	Weight
Typ 306-00 ZG Hi-Tru, with 1 set each outward or inward stepped jaws								
80	3 <sup>1/4</sup>	56	3	50,5	67	3xM6	4	1,7
100	4	70	3	63	83	3xM8	5	3,6
125	5	95	4	72	108	3xM8	5	5,6
160	6 <sup>1/4</sup>	125	4	81	140	3xM10	6	10
200	8	160	4	89,5	176	3xM10	6	17,2
250	10	200	5	102	224	3xM12	8	34,5
315	12 <sup>1/2</sup>	260	5	122	286	3xM16	8	57,5

Size A	Inch	B <sup>+0.02</sup>	C	D	F	G	SW	Weight
Typ 306-04 ZG Hi-Tru, with special seal for grinding machines								
80	3 <sup>1/4</sup>	56	3	50,5	67	3xM6	4	1,7
100	4	70	3	63	83	3xM8	5	3,6
125	5	95	4	72	108	3xM8	5	5,6
160	6 <sup>1/4</sup>	125	4	81	140	3xM10	6	10
200	8	160	4	89,5	176	3xM10	6	17,2
250	10	200	5	102	224	3xM12	8	34,5
315	12 <sup>1/2</sup>	260	5	122	286	3xM16	8	57,5

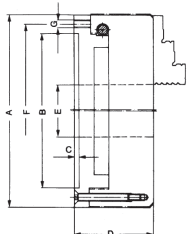

## Jaws ZG Hi-Tru

Tool group A09  
Type 300 **Inside jaw BB DIN 6350**  
outward stepped jaw, hardened  
suitable for ZG-ZS, ZGU-ZSU,  
ZG Hi-Tru

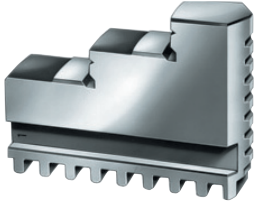

Item no.	Chuck Size	Number of jaws	Jaw length	Jaw height	Jaw width
110155 ●	80	3	37	26	12
110156 ●	100	3	48	33,5	14
110157 ●	125	3	52	41,5	18
110159 ●	160	3	61	47,5	18
110160 ●	200	3	69	53,5	20
110161 ●	250	3	90	67,5	24
110162 ●	315	3	130	79,5	34

<sup>1)</sup> reversible, for use as turning or inside jaws  
Stepped and hardened jaws, supplied as supplement or as spares, must be ground on the chuck.  
In case of a subsequent jaw delivery please return the chuck.

Tool group A09  
Type 300 **Outside jaw DB DIN 6350**  
inward stepped jaw, hardened

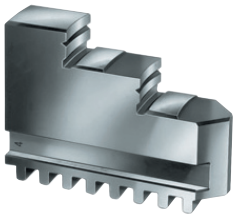

Item no.	Chuck Size	Number of jaws	Jaw length	Jaw height	Jaw width
110165 ●	80	3	37	26	12
110166 ●	100	3	48	33,5	14
110167 ●	125	3	52	41,5	18
110169 ●	160	3	61	47,5	18
110170 ●	200	3	69	53,5	20
110171 ●	250	3	90	67,5	24
110016 ●	315	3	130	79,5	34

Stepped and hardened jaws, supplied as supplement or as spares, must be ground on the chuck.  
In case of a subsequent jaw delivery please return the chuck.

Tool group A09  
Type 301 **Unstepped jaw BL DIN 6350**  
unstepped, soft, 16MnCr5



Item no.	Chuck Size	Number of jaws	Jaw length	Jaw height	Jaw width
107588 ●	80	3	37	26	12
107589 ●	100	3	48	33,5	14
107590 ●	125	3	52	41,5	18
107592 ●	160	3	61	47,5	18
107593 ●	200	3	69	53,5	20
107594 ●	250	3	90	67,5	24
107595 ●	315	3	130	79,5	34

<sup>1)</sup> jaws reversible

Tool group A09  
Type 302 **Base jaw GB DIN 6350**  
with fixing screw

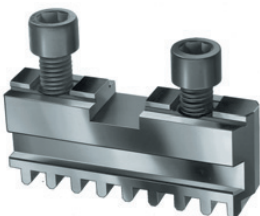

Item no.	Chuck Size	Number of jaws	Jaw length	Jaw width
107500 ●	100	3	46	14
107501 ●	125	3	55	18
107503 ●	160	3	65	18
107504 ●	200	3	78	20
107505 ●	250	3	92	24
107506 ●	315	3	108	34



# Jaws ZG Hi-Tru

Tool group A09  
Type 303 **Reversible top jaws UB**  
DIN 6350  
hardened

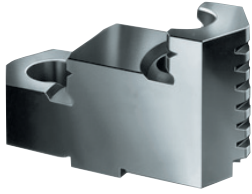

Item no.	Chuck Size	Number of jaws	Jaw length	Jaw height	Jaw width
108045 ■	100	3	47	29,5	22
108046 ■	125	3	56	37,5	26
107936 ●	160	3	66,7	41,5	28
107937 ●	200	3	79,5	42,5	30
108049 ●	250	3	95,3	52,5	36
108050 ●	315	3	109,5	57,5	42

Stepped and hardened jaws, supplied as supplement or as spares, must be ground on the chuck.  
In case of a subsequent jaw delivery please return the chuck.

Tool group A09  
Type 302 **Unstepped top jaw AB**  
DIN 6350  
soft, material 16MnCr5



Item no.	Chuck Size	Number of jaws	Jaw length	Jaw height	Jaw width
107633 ●	100	3	53	30	22,5
107634 ●	125	3	62	38	26,5
108581 ●	160	3	74	42	28,5
108582 ●	200	3	87	43	30,5
107637 ●	250	3	103	53	36,5
107638 ●	315	3	120	58	42,5

Tool group A09  
Type 301 **Unstepped jaw BL, special length**, soft, 16MnCr5  
DIN 6350

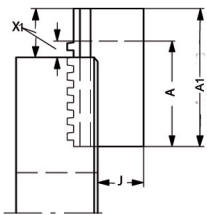
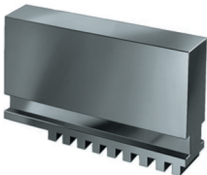

Item no.	Chuck Size	Number of jaws	A1	X1 max	A	J	X1 max.
130031 ■	200	3	100	50	69	32,5	19
132658 ■	250	3	120	56	90	41	26
132184 ■	315	3	160	70	130	46	40
130033 ■	200	3	120	70	69	32,5	19
128880 ■	250	3	140	76	90	41	16
118908 ■	315	3	200	110	130	46	40
121367 ■	315	3	250	160	130	46	40

Tool group A09  
Type 301 **Unstepped jaw BL, special height**, soft, 16MnCr5  
DIN 6350

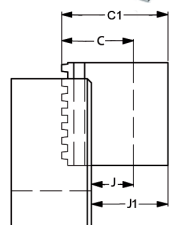

Item no.	Chuck Size	Number of jaws	C1Jaw height	J1	C	J
125710 ■	200	3	80	58,5	54	32,5
122188 ■	250	3	100	73	68	41
132186 ■	315	3	110	76	80	46
125712 ■	200	3	120	98,5	54	32,5
122189 ■	250	3	130	103	68	41
137096 ■	315	3	140	106	80	46
125714 ■	200	3	150	128,5	54	32,5
137102 ■	250	3	150	123	68	41
137104 ■	315	3	160	126	80	46

# Jaws ZG Hi-Tru

Tool group A09  
Type 302 **Top jaw AB,**  
**special length,** soft, 16MnCr5  
DIN 6350

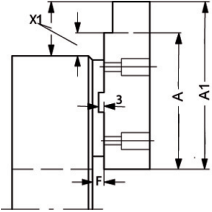
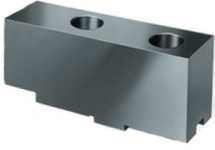

Item no.	Chuck Size	Number of jaws	Jaw length	F	A	X1 max.
110086	200	3	100	6,8	87	30
112122	250	3	130	8	103	36
110624	315	3	160	5,5	120	36
112120	200	3	120	6,8	87	30
125428	250	3	150	8	103	36
112091	315	3	200	5,5	120	36
104710	250	3	180	8	103	36
112089	315	3	250	5,5	120	36

Tool group A09  
Type 302 **Top jaw AB,**  
**special height,** soft, 16MnCr5  
DIN 6350

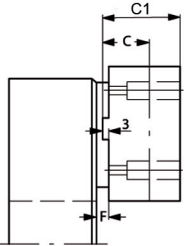

Item no.	Chuck Size	Number of jaws	C1	C	F
132155	200	3	60	43	6,8
119645	250	3	70	53	8
110435	315	3	80	58	5,5
128564	200	3	80	43	6,8
128571	250	3	100	53	8
110437	315	3	110	58	5,5
128573	250	3	150	53	8
128569	315	3	150	58	5,5

Tool group A09  
Type 302 **Top jaw AB, special**  
**width and height,** soft, 16MnCr5  
DIN 6350

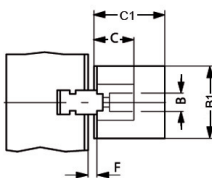
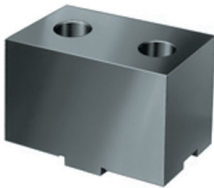

Item no.	Chuck Size	Number of jaws	Jaw height	C1	B	C
105057	200	3	40	70	30,5	43
137090	250	3	50	80	36,5	53
143053	315	3	60	90	42	58
133259	200	3	50	80	30,5	43
133653	250	3	60	90	36,5	53
143057	315	3	80	110	42	58

Tool group C15  
Type 0040-Y **Mounting bolt for**  
**top jaws**  
**bolt 1**

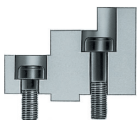

Item no.	Size	Thread
249299	100/110	M6x20
236949	125	M8x25
334571	140/160/200	M8x30
233025	250	M12x40
233026	315	M12x45

Tool group C15  
Type 0040-Y **Mounting bolt for**  
**top jaws**  
**bolt 2**



Item no.	Size	Thread
216528	100/110	M6x16
233058	125/140/160/200	M8x20
227692	250	M12x25
233030	315	M12x30

## Accessories ZG Hi-Tru

Tool group A09

Type 600 **Base plates** for lathe chucks with **cylindrical centre mount** DIN 6350

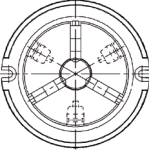
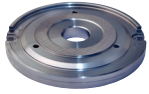

Item no.	Size
162793 <span style="color: yellow;">■</span>	160
162401 <span style="color: yellow;">■</span>	200
163036 <span style="color: yellow;">■</span>	250
133705 <span style="color: yellow;">■</span>	315

Tool group A09

Type 304 **Unfinished adapter plates** for **cylindrical mount** The unfinished back plate must be machined and fitted on both machine and chuck side

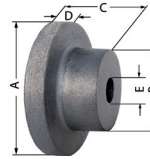

Item no.	Chuck Size	Inch	A	B	C	D	E
017113 <span style="color: green;">●</span>	80	3 1/4	92	56	47	15	20
017114 <span style="color: green;">●</span>	100	4	120	80	58	20	25
017115 <span style="color: green;">●</span>	125	5	135	80	58	20	25
017116 <span style="color: green;">●</span>	160	6 1/4	170	80	58	20	30
017117 <span style="color: green;">●</span>	200	8	210	92	66	22	40
017118 <span style="color: yellow;">■</span>	250	10	260	105	92	25	50
017119 <span style="color: yellow;">■</span>	315	12 1/2	330	165	100	30	50

Tool group A09

Type 300 **Chip guard, piece**



Item no.	Contents of delivery	Size
108500 <span style="color: yellow;">■</span>	piece	80/85
108501 <span style="color: green;">●</span>	piece	100/110
108502 <span style="color: green;">●</span>	piece	125
108503 <span style="color: green;">●</span>	piece	140/160
108504 <span style="color: green;">●</span>	piece	200
108505 <span style="color: green;">●</span>	piece	250
108506 <span style="color: green;">●</span>	piece	315/350/400

Tool group A09

Type 1028 **Special grease F80** for **lathe chucks** for lubrication and conservation of chucking power



Item no.	Design	Contents
028975 <span style="color: green;">●</span>	Tin	1 kg

Tool group A09

Type 300 **Scroll**



Item no.	Size
102183 <span style="color: green;">●</span>	80/85
101754 <span style="color: green;">●</span>	100
101721 <span style="color: green;">●</span>	125
100303 <span style="color: green;">●</span>	160
100003 <span style="color: green;">●</span>	200
100203 <span style="color: green;">●</span>	250
101552 <span style="color: green;">●</span>	315

Tool group A09

Type 300 **Driving pinion**



Item no.	Size	Hexagon
178473 <span style="color: green;">●</span>	100	9
178474 <span style="color: green;">●</span>	110	9
178475 <span style="color: green;">●</span>	125	10
178476 <span style="color: green;">●</span>	140	10
178477 <span style="color: green;">●</span>	160	11
178478 <span style="color: green;">●</span>	200	12
178479 <span style="color: yellow;">■</span>	230	12
178480 <span style="color: green;">●</span>	250	14
178481 <span style="color: yellow;">■</span>	270	14
178482 <span style="color: green;">●</span>	315	17

Tool group A09

Type 300 **Pinion holder screw**



Item no.	Size
102185 <span style="color: green;">●</span>	85
100305 <span style="color: green;">●</span>	160
100006 <span style="color: green;">●</span>	270
101554 <span style="color: green;">●</span>	315

Tool group A09

Type 300 **Standard key**



Item no.	Size	Square	Length
107426 <span style="color: green;">●</span>	80/85	6	62
107427 <span style="color: green;">●</span>	100/110	8	75
107428 <span style="color: green;">●</span>	125/140	9	80
107429 <span style="color: green;">●</span>	160	10	90
107430 <span style="color: green;">●</span>	200/230	11	100
107431 <span style="color: green;">●</span>	250/270	12	100
107432 <span style="color: green;">●</span>	315	14	110

Tool group A09

Type 300 **Safety key with ejector**



Item no.	Size	Square	Length
154370 <span style="color: yellow;">■</span>	80/85	6	110
154371 <span style="color: green;">●</span>	100/110	8	130
154372 <span style="color: green;">●</span>	125/140	9	130
154373 <span style="color: green;">●</span>	160	10	160
154374 <span style="color: green;">●</span>	200/230	11	160
154375 <span style="color: green;">●</span>	250/270	12	160
154376 <span style="color: green;">●</span>	315	14	200

Tool group A09

Type 300 **Elongated safety key with ejector**



Item no.	Size	Square	Length
154683 <span style="color: green;">●</span>	125/140	9	170
154685 <span style="color: green;">●</span>	160	10	180
154687 <span style="color: green;">●</span>	200/230	11	200
154689 <span style="color: green;">●</span>	250/270	12	200
154695 <span style="color: green;">●</span>	315	14	250

Tool group A09

Type 300 **Safety key with ejector** for actuating the chuck with torque (defined torque introduction)



Item no.	Size	Square	Inch
178566 <span style="color: green;">●</span>	80/85	6	1/2
178567 <span style="color: green;">●</span>	100/110	8	1/2
178568 <span style="color: green;">●</span>	125/140	9	1/2
178569 <span style="color: green;">●</span>	160	10	1/2
178570 <span style="color: green;">●</span>	200/230	11	1/2
178571 <span style="color: green;">●</span>	250/270	12	1/2
178572 <span style="color: green;">●</span>	315/350	14	1/2

Tool group A09

Type 0040-Y **Mounting screws** with **cylindrical centre rim**



Item no.	Size	Thread
249299 <span style="color: green;">●</span>	74-85	M6x20
334571 <span style="color: green;">●</span>	100-140	M8x30
249301 <span style="color: green;">●</span>	160-230	M10x35
233025 <span style="color: green;">●</span>	250-270	M12x40
220565 <span style="color: green;">●</span>	315-350	M16x50

# Chuck dimensions ZS-ZSU, ZG-ZGU and ZGF

For mounting on dividing heads and other attachments from the front, the lathe chucks with a cylindrical centre mount can also be supplied pre-drilled (at surcharge) G1, it is also possible to enlarge the bore (measure E, at surcharge)

### Cylindrical centre mount DIN 6350

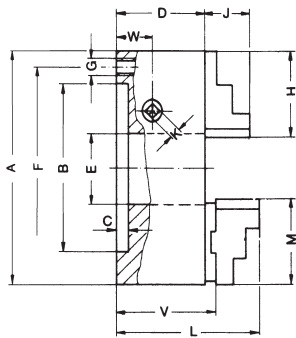

Enlarged bore max.

Size A	74	80	85	100	110	125	140	160	200	250	315	350	400	500	630
B <sup>H6</sup>	56	56	60	70	80	95	105	125	160	200	260	290	330	420	545
C	2,5	3	3	3	3	4	4	4	4	5	5	6	5	5	7
D	32,5	39,5	39,5	50	50	56	60	65	73,5	82	95	100	105	120	135
E	15	19	19	20	27	32	40	42	55	76	103	115	136	190	240
E <sub>max</sub>	-	-	-	21	-	33	43	50	70	92	114	120	150	210	253
F	63	67	72	83	95	108	120	140	176	224	286	318	362	458	586
G	3xM6	3xM6	3xM6	3xM8	3xM8	3xM8	3xM8	3xM10	3xM10	3xM12	3xM16	3xM16	3xM16	6xM16	6xM16
G <sub>1</sub>	-	-	-	-	-	3xØ9*	-	3xØ10,5	3xØ11	3xØ14	3xØ14	-	3xØ18	6xØ18	6xØ18
H	32	37	37	48	48	52	61	69	90	130	130	130	130	190	190
J	14	14	14	18	18	22,5	22,5	26	32,5	40	46	45	43	54,5	54,5
K	6 <sup>1)</sup>	6	6	8	8	9	9	10	11	12	14	14	17	19	19
L	-	-	-	80,5	-	95,5	106	108	119,6	139,6	155	168,5	171,5	201,5	216,5
M	-	-	-	47	47	56	66,7	66,7	79,5	95	109,5	127	127	127	127
V	-	-	-	53,6	53,6	61	67,7	69,7	80,2	89,9	100,4	110,4	113,4	128,4	143,3
W	13	14,5	14,5	18	18	20	21	22,45	25,7	26,5	30	34	35	38	48
approx. kg	1	1,3	1,9	2,9	3,4	4,5	5,8	8,2	14,6	25,7	44,2	56	80	126	208

G1 = Mounting from front

\* 4-jaw

### Cylindrical centre mount

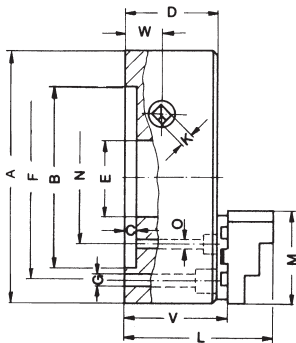

Enlarged bore max.

Size	ØA	700	800	1000	1250
B	610	710	910	910	910
C <sup>2)</sup>	7 <sup>+0,03</sup>	7 <sup>+0,03</sup>	7 <sup>+0,03</sup>	7 <sup>+0,03</sup>	7 <sup>+0,03</sup>
D	147	147	157	157	157
E	310	380	460	550	550
E <sub>max</sub>	330	420	580	580	580
F	660	760	950	950	950
3-Jaw	G	6xØ22	6xØ22	6xØ26	6xØ26
4-Jaw	G	8xØ22	8xØ22	8xØ26	6xØ26
K	19	19	24	24	24
L	240,6	240,6	269,6	269,6	269,6
M	210	210	210	210	210
N	360	460	610	610	610
3-Jaw	O	6xØ18	6xØ18	6xØ18	6xØ18
4-Jaw	O	4xØ18	4xØ18	4xØ18	6xØ18
V	158	158	166	166	166
W	48	48	53	53	53
approx. kg	280	350	590	850	850

1) Hexagon

2) Adaptor plate dimension 7<sub>-0,03</sub>

Position of fixing screws and pinions on lathe chucks with cylindrical centre mount sizes 74-630 (size 350 on request)

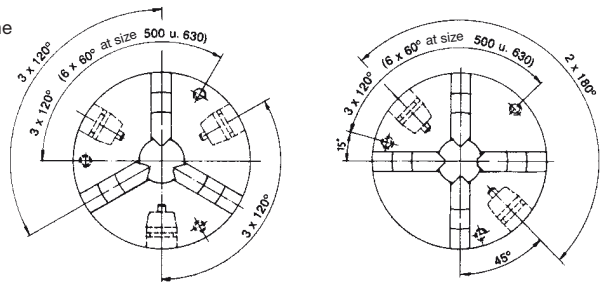

### Short taper mount

DIN 55021, with setscrews and locknuts



DIN 55027, with setscrews and locknuts

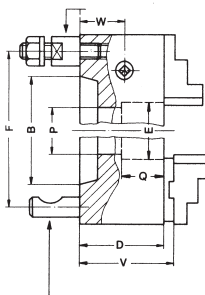

DIN 55029, with studs for Camlock

Size	A	100	125	140	160	200
Taper size		3	4	3	4	5
B	53,9	53,9	63,5	53,9	63,5	82,5
D	75	69	69	74	74	66
E	20	32	32	40	40	42
DIN	F	75	75	85	75	85
Caml.	F	70,6	70,6	82,5	70,6	82,5
P	-	-	-	-	-	51,2
Q	-	-	-	-	-	33
V	78,3	73,7	73,7	81,7	81,7	70,7
W	43	33	33	35	35 <sup>1)</sup>	23,45
Mounting holes	DIN	3	3	3	4	3
		3	3	3	6	3
ca. kg		4	5,5	7	8,5	15,5

1) 50 with Camlock, other dimensions in the table on the top



# Chuck dimensions ZG-ZS, ZGU-ZSU and ZGF

Short taper mount

DIN 55021,  
with setscrews and locknuts

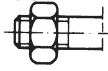

DIN 55027,  
with studs and nuts

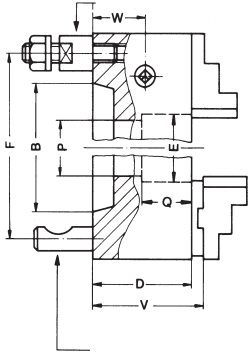

DIN 55029,  
with studs for Camlock

Size A	250				315				350			400		
Taper size	4	5	6	8	5	6	8	11	6	8	11	6	8	11
B	63,5	82,5	106,4	139,7	82,5	106,4	139,7	196,9	106,4	139,7	196,9	106,4	139,7	196,6
D	83	83	83	83	96	96	96	104	122	122	122	106	106	106
E	60,7	76	76	76	79,6	103	103	103	103	115	115	103	136	136
F	85	104,8	133,4	171,4	104,8	133,4	171,4	235	133,4	171,4	235	133,4	171,4	235
P	60,7	-	-	-	79,6	-	-	-	103	-	-	103	-	-
Q	40,5	-	-	-	49	-	-	-	81	-	-	54	-	-
V	90,9	90,9	90,9	90,9	101,4	101,4	101,4	109,4	127,4	127,4	127,4	114,4	114,4	114,4
W	27,5	27,5	27,5	27,5	31	31	31	39	56	56	56	36	36	36
Mounting holes	DIN 3	4	4	4	4	4	4	6	4	4	6	4	4	6
	Caml. 3	6	6	6	6	6	6	6	6	6	6	6	6	6
approx. kg	30				50				71			84		

Size A	500			630		700		800		1000		1250	
Taper size	8	11	15	11	15	11	15	15	20	15	20	15	20
B	139,7	196,9	285,8	196,9	285,8	196,9	285,8	285,8	412,8	285,8	412,8	285,8	412,8
D	122	122	122	137	137	149	149	149	149	159	159	159	159
E	136	190	190	192,7	240	310	310	380	380	460	460	550	550
F	171,4	235	330,2	235	330,2	235	330,2	330,2	463,6	330,2	463,6	330,2	463,6
P	136	-	-	192,7	-	192,7	281,2	281,2	-	281,2	407,5	281,2	407,5
Q	61	-	-	63	-	76	76	76	-	85	85	85	85
V	130,4	130,4	130,4	145,3	145,3	160	160	160	160	168	168	168	168
W	40	40	40	50	50	50	50	50	50	55	55	55	55
Mounting holes	DIN 4	6	6	6	6	6	6	6	6	6	6	6	6
	Caml. 6	6	6	6	6	6	6	6	6	6	6	6	6
approx. kg	150			225		280		350		590		850	

All other dimensions should be taken from the table about chucks with cylindrical centre mount

Short taper mount

DIN 55026  
Mounting from front

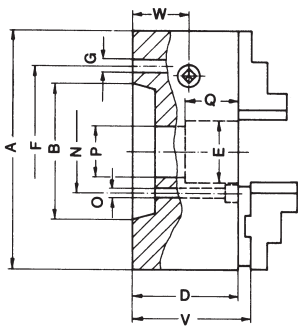

Size A	160		200		250		315		350		400	
Taper size	5	5	6	5	6	8	6	8	6	8	8	11
B	82,5	82,5	106,4	82,5	106,4	139,7	106,4	139,7	106,4	139,7	139,7	196,9
D	66	74,5	74,5	83	83	83	96	96	122	122	106	106
E	42	42	55	76	55	76	103	76	103	76	136	125
F <sup>2)</sup>	-	-	-	104,8	-	-	133,4	-	133,4	-	171,4	-
G	-	-	-	11 <sup>1)</sup>	-	-	14	-	14	-	18	-
N <sup>3)</sup>	61,9	61,9	82,6	-	82,6	111,1	-	111,1	-	111,1	-	165,1
O	11 <sup>1)</sup>	11 <sup>1)</sup>	14	-	14	18	-	18	-	18	-	22
V	70,7	81,2	81,2	90,9	90,9	90,9	101,4	101,4	127,4	127,4	114,4	114,4
W	23,45	26,7	26,7	27,5	27,5	27,5	31	31	56	56	36	36
Mounting holes	*	3	3	6	3	6	6	6	6	6	6	6
	**	4	4	4	4	4	4	4	4	4	4	4
approx. kg	8		14,5		25		44,5		71		82	

Size ØA	500		630		700		800		1000		1250	
Taper size	11	11	15	11	15	11	15	20	15	20	15	20
B	196,9	196,9	285,9	196,9	285,9	196,9	285,9	412,8	285,9	412,8	285,9	412,8
D	122	137	137	149	149	149	149	149	159	159	159	159
E	190	190	190	310	285	380	380	380	460	505	550	550
F <sup>2)</sup>	235	235	-	235	330,2	235	330,2	463,6	330,2	463,6	330,2	463,62
G	22	22	-	22	26	22	26	26	26	26	26	26
N <sup>3)</sup>	-	-	247,6	-	-	-	-	-	-	-	-	-
O	-	-	26	-	-	-	-	-	-	-	-	-
P	-	-	-	193	281,2	193	281,2	-	281,2	407,5	281,2	407,5
Q	-	-	-	76	76	76	76	-	85	85	85	85
V	130,4	145,3	145,3	159,9	159,9	159,9	159,9	159,9	168	168	168	168
W	40	50	60	50	50	50	50	50	55	55	55	55
Mounting holes	*	3	6	6	6	6	6	6	8	8	8	8
	**	4	8	8	8	8	8	8	8	8	8	8
approx. kg	139		220		295		350		590		850	

1) 12 with ASA B 5.9 inch thread      2) With DIN 55026 Forme A and B; DIN 55021 Forme A and B; ASA B 5.9 A1/A2  
 3) With DIN 55026 Forme B; ASA B 5.9 A1/B1      \* 3-Jaw      \*\* 4-Jaw

# Dimensions ZS-ZSU, ZG-ZGU und ZGF

## Chucking capacities of jaw steps (standard values)

### External chucking

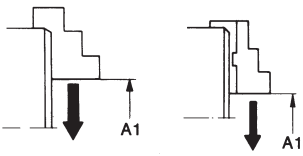

Size	74	80	85	100	110	125	140	160	200	250
A1 (BB)	2-24	2-30	2-30	3-38	3-42	3-53	3-53	3-72	4-100	5-122
A2 (DB)	2-24	2-30	2-30	3-38	3-42	3-53	3-53	3-72	4-100	5-122
A3 (DB)	23-46	27-55	27-55	38-71	39-77	39-89	47-97	47-116	56-152	73-190
A4 (DB)	45-68	52-80	52-80	70-100	70-100	75-125	91-140	91-160	104-200	131-250
max. swing dia.	88	104	104	128	138	157	174	194	238	302
Jaw movement	11	14	14	15	19	25	25	34	48	58

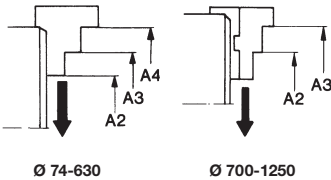

Size	315	350	400	500	630	700	800	1000	1250
A1	6-135	20-180	20-200	35-260	50-350	110-350	150-450	250-600	320-600
A2	6-135	20-180	20-200	35-260	50-350	280-672	325-853	425-1070	490-1150
A3	96-225	110-270	110-300	140-360	190-490	356-748	400-928	500-1150	564-1224
A4	186-315	200-350	200-400	280-500	330-630	-	-	-	-
max. swing dia.	395	440	480	600	730	1000	1170	1390	1476
Jaw movement	64	80	100	110	150	120	150	175	140

### Internal chucking

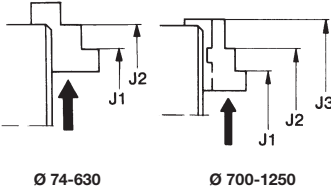

Size	74	80	85	100	110	125	140	160	200	250
J1	23-46	25-53	25-53	33-66	33-71	37-87	39-89	39-107	44-140	59-165
J2	45-68	50-78	50-78	65-94	65-104	73-123	83-132	83-152	92-186	119-236

Size	315	350	400	500	630	700	800	1000	1250
J1	96-224	100-260	100-300	135-355	150-450	212-648	251-855	356-1080	426-1162
J2	186-305	190-350	190-390	275-460	290-590	290-758	326-930	430-1150	500-1236
J3	-	-	-	-	-	526-922	566-1094	660-1314	740-1400

Clamping ranges for lathe chucks with individual adjustable jaws (EG-ES) are in approximate conformity with the above values. They are valid for 3- and 4-jaw chucks and lathe chucks with reversible jaws. Do not exceed maximum chucking ranges.

### Max. permissible speeds for ZG-ZS, ZGU-ZSU, ZG Hi-Tru chucks to DIN 6350

The maximum permissible speed has been fixed so that 1/3 of the gripping force is still available as residual gripping force if the maximum gripping is applied and the chuck is fitted with its heaviest jaws. The jaws may not project beyond the outside diameter of the chuck. The chuck must be in perfect condition. The speed limit for chucks with cast iron bodies is based on the permissible peripheral speed for cast iron. The specification DIN 6386 Part 1 shall be observed.

Size	3 and 4 jaws	
	Cast iron body	Steel body
74	5000	-
80	5000	7000
100	4500	6300
125	4000	5500
140	3700	5000
160	3600	4600
200	3000	4000
250	2500	3000
315	2000	2300
350	1700	1900
400	1600	1800
500	1000	1300
630	800	850
700	650	800
800	600	700
1000	480	560
1250	380	450

# Jaw dimensions ZS-ZSU, ZG-ZGU, ZGF, ZG Hi-Tru

Dimensions F and G apply to outward stepped jaws BB  
 Dimensions J and K apply to inward stepped jaws DB

Outward stepped jaw (inside jaw) BB

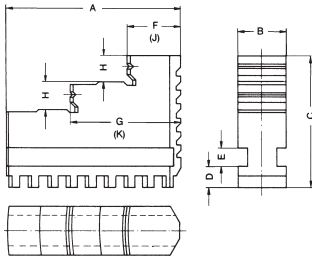

Size	74 <sup>1)</sup>	80/85	100/110	125	140	160	200	250	315	300/400	500/630
A	32	37	48	52	61	61	69	90	130	130	190
B	10	12	14	18	18	18	20	24	34	34	42
C	23	26	33,5	41,5	41,5	47,5	53,5	67,5	79,5	79,5	95
D	4,7	4,8	6,3	7,3	8,3	8,3	8,3	10,3	11,3	11,3	14,9
E	4	4,5	6	7	7	7	8	10	15	15	15
F	10	12	15	17	18	18	20	27	41,5	41,5	50
G	21	24,5	31	35	40	40	44	57	86,5	86,5	120
H	5	6	6	8	8	10	10	14	15	15	20
J	-	12	14	16	17	17	19	26	40	40	50
K	-	24,5	30	34	39	39	43	56	85	85	120
Jaw approx. kg	BB	0,03	0,05	0,1	0,2	0,22	0,25	0,3	0,7	1,8	3,8
	BL	0,05	0,08	0,15	0,27	0,32	0,38	0,52	1	2,4	5,2

Unstepped jaw, soft (block jaw) BL

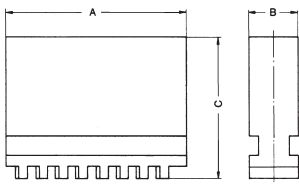

1) Reversible jaws

Base jaw GB

Ø 100-400

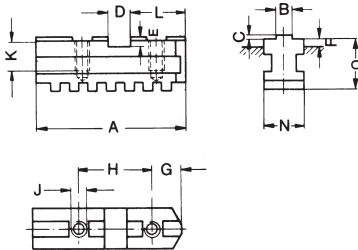

Size	100/110	125	140	160	200	250	315	350/400	500	630
A	46	55	65	65	78	92	108	127	165	203
B <sub>0,05</sub>	7,94	7,94	7,94	7,94	7,94	12,7	12,7	12,7	12,7	12,7
C	2,5	3,1	3,1	3,1	3,1	3,1	3,1	3,1	3,1	3,1
D <sup>+0,01</sup>	9,5	12,68	12,68	12,68	12,68	19,03	19,03	19,03	19,03	19,03
E	6	7,6	7,6	7,6	7,6	7,6	7,6	10,8	10,8	10,8
F	3,4	4,8	7,8	4,8	6,8	8	5,5	10,5 <sup>2)</sup>	8,5	8,5
G	12	13	15,8	15,8	19	22,2	25,4	28,5	28,5	28,5
H	24	32	38,1	38,1	44,45	54	63,5	76,2	38,1	38,1
J	metr.	M6	M8	M8	M8	M12	M12	M16	M20	M20
	UNC	1/4"-20	5/16"-18	3/8"-16	3/8"-16	1/2"-13	1/2"-13	5/8"-11	3/4"-10	3/4"-10
K	12	14,5	16	16	16	20	25	29	33	33
L	19,25	22,6	28,5	28,5	34,9	39,7	47,6	57,1	57,1	57,1
M	-	-	-	-	-	-	-	-	38,1	38,1
N	14	18	18	18	20	24	34	42	42	42
O	19,5	24	27	27	28	35	40	45	49	49
Grooves	1	1	1	1	1	1	1	1	2	3
Tapped holes	2	2	2	2	2	2	2	2	4	5
Jaw approx. kg	0,06	0,12	0,17	0,17	0,22	0,4	0,78	1	1,72	2,1

Ø 500-630

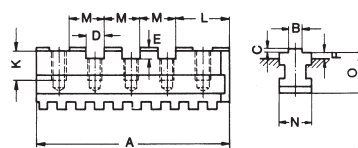

Ø 700-1250

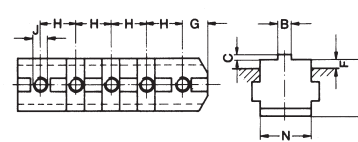

Size	700	800	1000	1250
A	253	291	329	367
B <sub>0,05</sub>	12,7	12,7	12,7	12,7
C	3,1	3,1	3,1	3,1
D <sup>+0,01</sup>	19,03	19,03	19,03	19,03
E	10,8	10,8	10,8	10,8
F	11	11	9	9
G	28,5	28,5	28,5	28,5
H	38,1	38,1	38,1	38,1
J	metr.	M20	M20	M20
	UNC	3/4"-10	3/4"-10	3/4"-10
K	37	37	37	37
L	57,1	57,1	57,1	57,1
M	38,1	38,1	38,1	38,1
N	55	55	55	55
O	62	62	62	62
Grooves	4	5	6	7
Tapped holes	6	7	8	9
Jaw approx. kg	6,2	7,1	8	9

1) Reversible jaws      2) Size

# Jaw dimensions ZS-ZSU, ZG-ZGU, ZGF, ZG Hi-Tru

Reversible top jaw UB

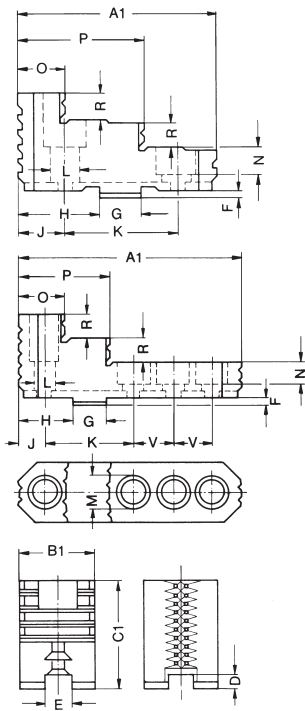

Chuck size		100 110	125	140 160	200 230	250 270	315	350 400	500 630	700 800	1000 1250
A	1	47	56	66,7	79,5	95,3	109,5	127	127	210	210
	2	53	62	74	87	103	120	137	140	210	210
B	1	22	26	28	30	36	42	42	50	68	68
	2	22,5	26,5	28,5	30,5	36,5	42,5	42,5	50,5	68	68
C	1	29,5	37,5	41,5	42,5	52,5	57,5	64,5	79,5	89	110
	2	30	38	42	43	53	58	65	80	89	110
D		5,5	7,6	7,6	7,6	7,6	7,6	10,8	10,8	10,8	10,8
E		7,96	7,96	7,96	7,96	12,72	12,72	12,72	12,72	12,72	12,72
F		2,5	3,1	3,1	3,1	3,1	3,1	6,35	6,35	6,35	6,35
G		9,50	12,68	12,68	12,68	19,03	19,03	19,03	19,03	19,03	19,03
H		19,25	22,6	28,5	34,9	39,7	47,6	57,1	57,1	57,1	57,1
J		12	13	15,8	19	22,2	25,4	28,5	28,5	28,5	28,5
K		24	32	38,1	44,45	53,95	63,5	76,2	76,2	76,2	76,2
L		6,6	9	9 <sup>1)</sup> 10,5 <sup>2)</sup>	9 <sup>1)</sup> 10,5 <sup>2)</sup>	14	14	18	22	22	22
M		11	15	15 <sup>1)</sup> 16 <sup>2)</sup>	15 <sup>1)</sup> 16 <sup>2)</sup>	20	20	26	33	33	33
N		7	9	10	10	13,5	13,5	17	21	21,5	21,5
O		12	13	15,8	19	22,2	25,4	28,5	54,6	51	51
P		29,5	35	42,8	51,5	60,2	67,4	77	88,5	89	89
R		6	8	10	10	14	15	15	20	22	25
S		22,25	25,6	32,2	38,7	43,5	52,9	62,1	63,6	70	70
T		15	16	19,5	22,8	26	30,7	33,55	35	41,5	41,5
U		19	27	30	30	41	43	47	61	65	71
V		-	-	-	-	-	-	-	-	38,1	38,1
Jaw approx. kg	UB	0,12	0,19	0,27	0,39	0,66	1,02	1,27	2	4,45	6,1
	AB	0,21	0,34	0,5	0,7	1,2	1,86	2,18	3,04	8	10,8

Saw-tooth standard model

Cross-grooving from size 250 available from size 700 standard-model

Unstepped top jaw soft AB

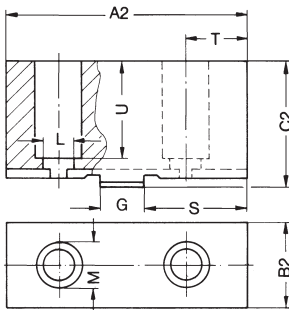

## Special-design jaws

for non-rotating clamping devices, for symmetrical components, for machine vices and NC-compact vices  
Available in all desired modifications

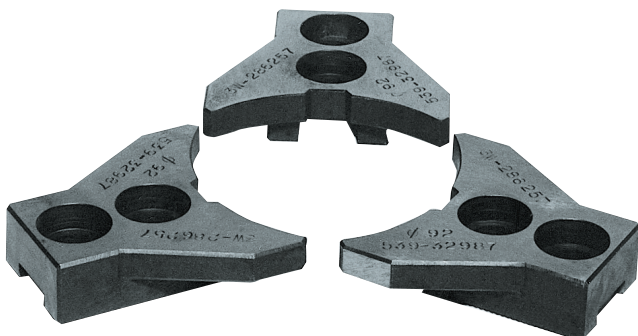



EG-ES

This chuck will be used for the adjustment of irregular shaped workpieces

**Mechanism**

The radial positioned Pinion (4, hardened) transmits the power via a bevel gearing to the Spiral Ring (3), where its spiral transmits it to the Base Jaws (13, hardened and grinded), the Adjusting Screw Spindle (16, hardened) and the reversible Top Jaws (14, hardened and grinded). Steel or cast iron body (1), Cover (2).

**Clamping force transmitting system**

The jaws can be moved across the entire clamping range by turning a key.

**Lubrication**

Lathe chucks must be lubricated regularly to maintain their gripping force. Appropriate directions are included in the operating instructions supplied with each chuck. All lathe chucks are equipped with grease nipples for convenient maintenance.

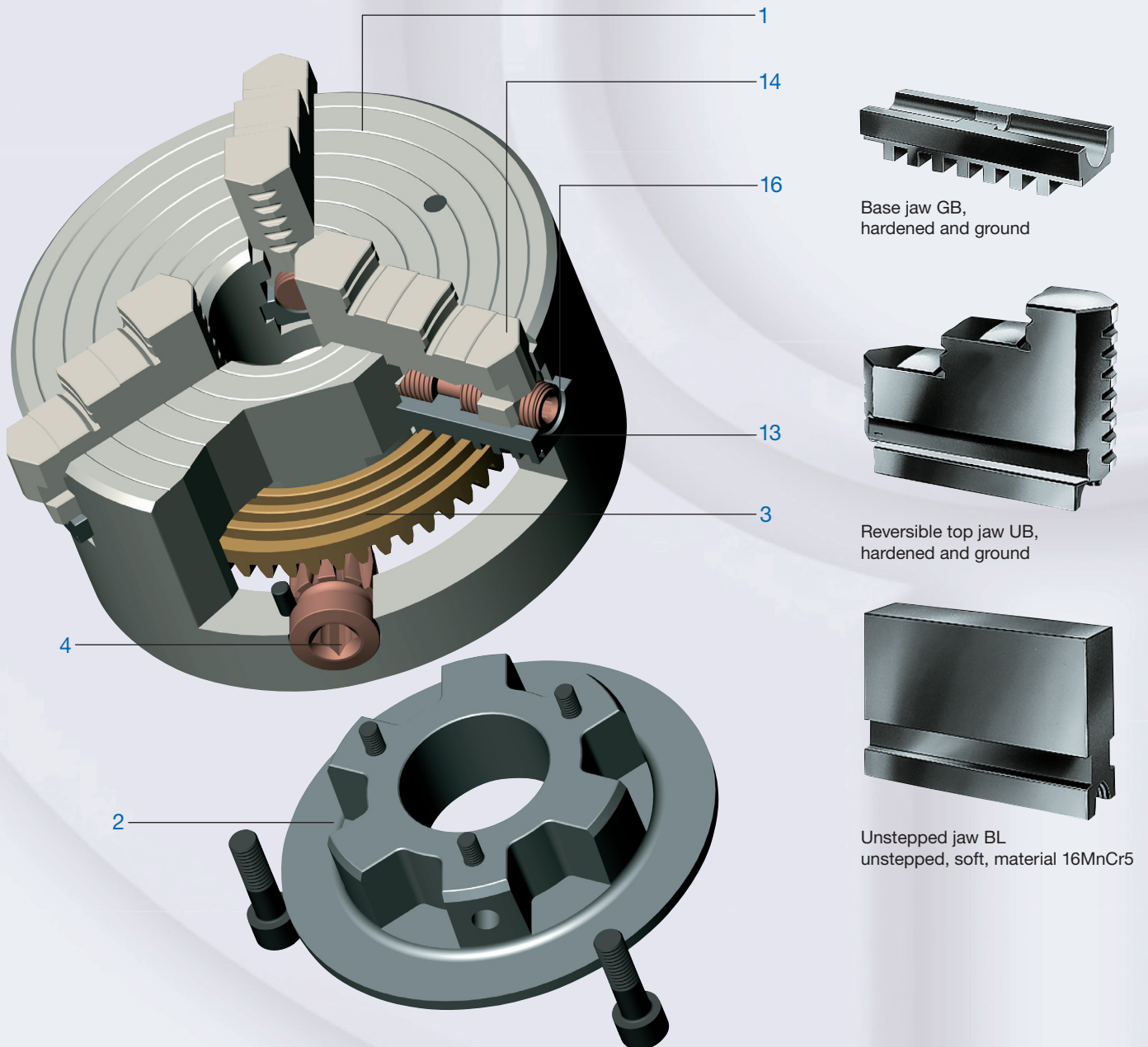

## Flex - EG-ES

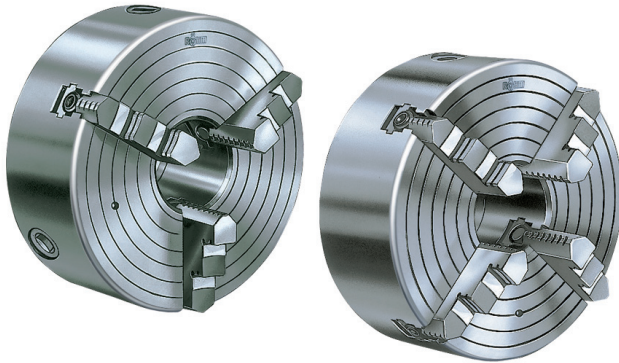

Three- and four-jaw chucks, cast iron or steel body, particularly suitable for lining up and chucking workpieces of irregular shape.

The jaws can be moved across the entire clamping range by turning a key.

### Technical features:

- similar to DIN 6350, but with additional adjustment of the reversible jaws
- dimensions and mountings to DIN 6351
- chuck body: drop-forged steel or special cast iron
- scroll: drop-forged and balanced, hardened
- with self-centering and independently adjustable jaws
- lathe chucks must be lubricated regularly to maintain their gripping force
- dimensions and mountings to DIN 6351

### Delivery includes:

- 1 set of base jaws (GB),
- 1 set of reversible jaws (UB),
- 1 operating key,
- 1 adjusting key, mounting bolts

Tool group A09  
Geared scroll chucks EG-ES  
**DIN 6351**; cylindrical centre mount, form A

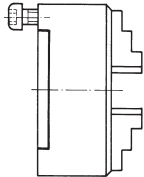

Size	ZA	Through-hole	3 jaw chuck steel	4 jaw chuck steel	3 jaw chuck cast iron	4 jaw chuck cast iron	Torque Nm	Total clamping force kN
100	70	20	-	-	104229	104229	60	27
125	95	32	-	-	104229	103362	80	31
160	125	42	111360	111789	104229	103362	110	47
200	160	55	111365	111793	104279	104327	140	55
250	200	76	111370	111797	104531	104579	150	63
315	260	103	111375	111801	104643	104687	180	69
400	330	136	111380	111805	104748	104790	240	92
500	420	190	111385	111809	105143	105173	260	100
630	545	240	111390	111813	104100	105657	280	105

Tool group A09  
Geared scroll chucks EG-ES  
**ISO 702-3** (DIN 55027), DIN 55022; with studs and locknuts, optional DIN 55021 with set screw and nut

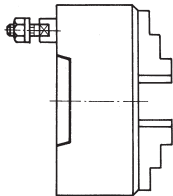

Size	Mount short taper	Through-hole	3 jaw chuck steel	4 jaw chuck steel	3 jaw chuck cast iron	4 jaw chuck cast iron	Torque Nm	Total clamping force kN
125	3	32	-	-	104207	104207	80	31
125	4	32	-	-	104207	104207	80	31
160	4	42	111468	111891	104207	103378	110	47
160	5	42	111469	111892	104209	103382	110	47
160	6	42	111471	111894	104211	103386	110	47
200	4	55	111475	111898	104315	104345	140	55
200	5	55	111472	111895	104285	104339	140	55
200	6	55	111473	111896	104287	104341	140	55
250	5	76	111478	111901	104545	104593	150	63
250	6	76	111476	111899	104541	104589	150	63
250	8	76	111477	111900	104543	104591	150	63
315	6	103	111479	111902	104653	104697	180	69
315	8	103	111480	111903	104655	104699	180	69
315	11	103	111481	111904	104657	104701	180	69
400	8	136	111482	111905	104758	105100	240	92
400	11	136	111483	111906	104760	105102	240	92
500	11	190	111485	111908	105151	105181	260	100
500	15	190	111486	111909	105153	105183	260	100
630	11	192,7	111488	111911	104108	106001	280	105
630	15	240	111489	111912	104109	106003	280	105

Tool group A09  
Geared scroll chucks EG-ES  
**ISO 702-1** (DIN 55026); DIN 55021, ASA B 5.9, A1/A2 metr.; mounting from front

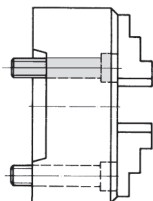

Size	Mount short taper	Through-hole	3 jaw chuck steel	4 jaw chuck steel	3 jaw chuck cast iron	4 jaw chuck cast iron	Torque Nm	Total clamping force kN
160	5	42	111515 <sup>1)</sup>	111938	104213	103390	110	47
200	5	42	111517 <sup>1)</sup>	111940	104290	104347	140	55
200	6	55	111519 <sup>1)</sup>	111942	104292	104349	140	55
250	6	55	111521 <sup>1)</sup>	111944	104547	104595	150	63
250	8	76	111523 <sup>1)</sup>	111946	104549	104597	150	63
315	6	103	111527	111950	104659	104703	180	69
315	8	76	111529 <sup>1)</sup>	111952	104661	104705	180	69
400	8	136	111531	111954	104764	105106	240	92
400	11	125	111533 <sup>1)</sup>	111956	104766	105108	240	92
500	11	190	111535	111958	105155	105185	260	100
630	11	190	111540	111963	104112	106005	280	105
630	15	190	111542 <sup>1)</sup>	111965	104113	106007	280	105

<sup>1)</sup> mounting from front in the inner bolt circle

## Flex - EG-ES

Tool group A09  
Geared scroll chucks EG-ES  
ISO 702-2 (DIN 55029); ASA B 5.9,  
Type D, with studs for Camlock

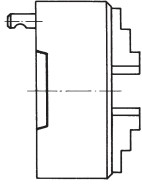

Size	Mount short taper	Through-hole	3 jaw chuck steel	4 jaw chuck steel	3 jaw chuck cast iron	4 jaw chuck cast iron	Torque Nm	Total clamping force kN
125	3	32	-	-	109405 ▲	109405 ▲	80	31
125	4	32	-	-	109405 ▲	109405 ▲	80	31
160	4	42	111604 ▲	112024 ▲	109405 ▲	109431 ▲	110	47
160	5	42	111606 ▲	112026 ▲	109407 ▲	109433 ▲	110	47
160	6	42	111610 ▲	112030 ▲	109410 ▲	109436 ▲	110	47
200	4	55	111618 ▲	112038 ▲	109406 ▲	109432 ▲	140	55
200	5	55	111612 ▲	112032 ▲	109408 ▲	109434 ▲	140	55
200	6	55	111614 ▲	112034 ▲	109411 ▲	109437 ▲	140	55
250	5	76	111624 ▲	112044 ▲	109409 ▲	109435 ▲	150	63
250	6	76	111620 ▲	112040 ▲	109412 ▲	109438 ▲	150	63
250	8	76	111622 ▲	112042 ▲	109415 ▲	109441 ▲	150	63
315	6	103	111626 ▲	112046 ▲	109413 ▲	109439 ▲	180	69
315	8	103	111628 ▲	112048 ▲	109416 ▲	109442 ▲	180	69
315	11	103	111630 ▲	112050 ▲	109419 ▲	109445 ▲	180	69
400	8	136	111632 ▲	112052 ▲	109417 ▲	109443 ▲	240	92
400	11	136	111634 ▲	112054 ▲	109420 ▲	109446 ▲	240	92
500	11	190	111638 ▲	112058 ▲	109421 ▲	109447 ▲	260	100
500	15	190	111640 ▲	112060 ▲	109423 ▲	109449 ▲	260	100
630	11	192,7	111644 ▲	112064 ▲	109422 ▲	109448 ▲	280	105
630	15	240	111646 ▲	112066 ▲	109424 ▲	109450 ▲	280	105

## Jaws EG-ES

Tool group A09  
Type 350 Reversible top jaws UB  
hardened

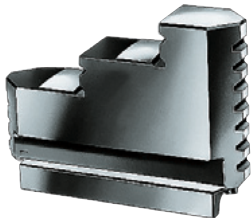

Chuck Size	3-jaw set	4-jaw set	Jaw length	Jaw height	Jaw width
125	110117 ■	110123 ■	56	41,5	18
160	110118 ■	110124 ■	69	50	20
200	139666 ■	139670 ■	85	57,5	24
250	139667 ■	139671 ■	90	67,5	24
315/400	139668 ■	139672 ■	130	79,5	34
500/630	139669 ▲	139673 ▲	190	95	42

Tool group A09  
Type 351 Unstepped jaw BL  
unstepped, soft

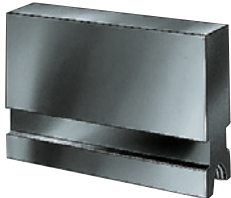

Chuck Size	3-jaw set	4-jaw set	Jaw length	Jaw height	Jaw width
125	107668 ■	107674 ■	56	41,5	18
160	107669 ■	107675 ■	69	50	20
200	139674 ■	139678 ■	85	57,5	24
250	139675 ■	139679 ■	90	67,5	24
315/400	139676 ■	139680 ■	130	79,5	34
500/630	139677 ■	139681 ■	190	95	42

Tool group A09  
Type 350 Base jaw GB

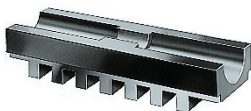

Chuck Size	3-jaw set	4-jaw set
100	107652 ■	107660 ■
125	107653 ■	107661 ■
160	107654 ■	107662 ■
200	139682 ●	139686 ●
250	139683 ■	139687 ■
315	139684 ■	139688 ■
400	139685 ■	139689 ■
500/630	107659 ■	107667 ■

# Accessories EG-ES

Tool group A09

Type 600 **Base plates** for lathe chucks with **cylindrical centre mount** DIN 6350

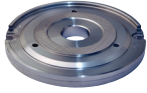

Item no.	Size
162793 <span style="color: yellow;">■</span>	160
162401 <span style="color: yellow;">■</span>	200
163036 <span style="color: yellow;">■</span>	250
133705 <span style="color: yellow;">■</span>	315

Tool group A09

Type 304 **Unfinished adapter plates** for **cylindrical mount**. The unfinished back plate must be machined and fitted on both machine and chuck side

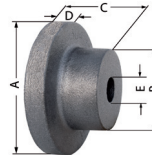

Item no.	Chuck Size	Inch	A	B	C	D	E
017114 <span style="color: green;">●</span>	100	4	120	80	58	20	25
017115 <span style="color: green;">●</span>	125	5	135	80	58	20	25
017116 <span style="color: green;">●</span>	160	6 ¼	170	80	58	20	30
017117 <span style="color: green;">●</span>	200	8	210	92	66	22	40
017118 <span style="color: yellow;">■</span>	250	10	260	105	92	25	50
017119 <span style="color: yellow;">■</span>	315	12 ½	330	165	100	30	50

Tool group C15

Type 1028 **Special grease F80** for **lathe chucks** for lubrication and conservation of chucking power



Item no.	Design	Contents
028975 <span style="color: green;">●</span>	Tin	1 kg

Tool group C15

Type 350 **Adjusting spindle**



Item no.	For chuck size
103199 <span style="color: green;">●</span>	100
104251 <span style="color: green;">●</span>	125
104271 <span style="color: green;">●</span>	160
137735 <span style="color: green;">●</span>	200
137643 <span style="color: green;">●</span>	250
137701 <span style="color: green;">●</span>	400
137716 <span style="color: green;">●</span>	500

Tool group A09

Type 350 **Adjusting key**



Item no.	For chuck size	Square	Hexagon
107444 <span style="color: green;">●</span>	160	5,5	-
139695 <span style="color: green;">●</span>	400	-	8
139696 <span style="color: green;">●</span>	500	-	12

Tool group A09

Type 300 **Scroll**



Item no.	Size
101754 <span style="color: green;">●</span>	100
101721 <span style="color: green;">●</span>	125
100303 <span style="color: green;">●</span>	160
100003 <span style="color: green;">●</span>	200
100203 <span style="color: green;">●</span>	250
101552 <span style="color: green;">●</span>	315
102497 <span style="color: green;">●</span>	400
162973 <span style="color: yellow;">■</span>	500
162964 <span style="color: yellow;">■</span>	630

Tool group A09

Type 300 **Driving pinion**



Item no.	Size	Hexagon
178473 <span style="color: green;">●</span>	100	9
178475 <span style="color: green;">●</span>	125	10
178477 <span style="color: green;">●</span>	160	11
178478 <span style="color: green;">●</span>	200	12
178480 <span style="color: green;">●</span>	250	14
178482 <span style="color: green;">●</span>	315	17
178483 <span style="color: green;">●</span>	400	19
178484 <span style="color: yellow;">■</span>	500	22
178485 <span style="color: yellow;">■</span>	630	22

Tool group A09

Type 300 **Pinion holder screw**



Item no.	Size
100305 <span style="color: green;">●</span>	160
100006 <span style="color: green;">●</span>	270
101554 <span style="color: green;">●</span>	315
102499 <span style="color: green;">●</span>	400
103300 <span style="color: green;">●</span>	630



## Accessories EG-ES

Tool group A09

Type 300 **Standard key**



Item no.	Size	Square	Length
107427 ●	100/110	8	75
107428 ●	125/140	9	80
107429 ●	160	10	90
107430 ●	200/230	11	100
107431 ●	250/270	12	100
107432 ●	315	14	110
107433 ●	350	14	140
107434 ●	400	17	140
107435 ●	500/630	19	150

Tool group A09

Type 300 **Safety key with ejector**



Item no.	Size	Square	Length
154371 ●	100/110	8	130
154372 ●	125/140	9	130
154373 ●	160	10	160
154374 ●	200/230	11	160
154375 ●	250/270	12	160
154376 ●	315	14	200
154377 ●	350	14	200
154378 ●	400	17	250
154379 ■	500/630	19	250

Tool group A09

Type 300 **Elongated safety key with ejector**



Item no.	Size	Square	Length
154683 ●	125/140	9	170
154685 ●	160	10	180
154687 ●	200/230	11	200
154689 ●	250/270	12	200
154695 ●	315	14	250

Tool group A09

Type 300 **Safety key with ejector** for actuating the chuck with torque (defined torque introduction)



Item no.	Size	Square	Inch
178566 ●	80/85	6	1/2
178567 ●	100/110	8	1/2
178568 ●	125/140	9	1/2
178569 ●	160	10	1/2
178570 ●	200/230	11	1/2
178571 ●	250/270	12	1/2
178572 ●	315/350	14	1/2

Tool group C15

Type 0040-Y **Mounting screws** for lathe chucks with **direct short-taper, for front mounting**



Item no.	Size	Thread	Chuck Size	Taper size
233059 ●	74	M10x70	160	5
308436 ●	80	M10x85	200	5
200186 ●	85	M12x85	200	6
234615 ●	100	M10x110	250	5
302215 ●	110	M12x90	250	6
202439 ●	125	M16x90	250	8
316244 ●	140	M12x120	315	6
308439 ●	160	M16x105	315	8
342701 ●	315	M16x130	400	8
698878 ●	350	M20x115	400	11
011528 ●	400	M20x155	500	11
358815 ●	500	M20x170	630	11
202509 ●	630	M24x150	630	15

Tool group C15

Type 310 **Set screw with nut DIN 55021**



Item no.	Thread	For taper	Quantity
107453 ●	M10x30	4	3
107455 ●	M10x35	5	4
107456 ●	M12x40	6	4
107457 ■	M16x45	8	4
107458 ■	M20x55	11	6
127618 ■	M24x65	15	6

Tool group A09

Type 315 **Stud and locknut ISO 702-3** (DIN 55027)



Item no.	Contents of delivery	Thread	For taper	Quantity
107447 ●	piece	M10x34	3	3
107448 ●	piece	M10x39	4	3
107449 ●	piece	M10x43	5	4
107450 ●	piece	M12x50	6	4
107451 ●	piece	M16x60	8	4
107452 ●	piece	M20x75	11	6
125650 ●	piece	M24x90	15	6

Tool group A09

Type 330 **Stud for Camlock ASA B 5.9** (DIN 55029) and **cylindrical studs**



Item no.	Thread	For taper	Quantity
107465 ●	7/16-20x35	3	3
107466 ●	7/16-20x37	4	3
107467 ●	1/2-20x43	5	6
107468 ●	5/8-18x49	6	6
107469 ●	3/4-16x55,5	8	6
107470 ●	7/8-14x67	11	6
127621 ▲	1-14x76	15	6

Tool group A09

Type 330 **Stud for Camlock ISO 702-2** (DIN 55029) and **cylindrical studs**



Item no.	Thread	For taper	Quantity
178364	M10x1	3	3
178365	M10x1	4	3
178366	M12x1	5	6
178367	M16x1,5	6	6
178368	M20x1,5	8	6
178369	M22x1,5	11	6
178370	M24x1,5	15	6
178371	M27x2	20	6

# Chuck Dimensions EG-ES

**Cylindrical centre mount DIN 6351**

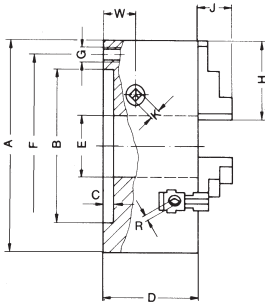

The bore could be enlarged (measure E, at surcharge)

Enlarged bore max.

Size A	100	125	160	200	250	315	400	500	630
BH6	70	95	125	160	200	260	330	420	545
C	3	4	4	4	5	5	5	5	7
D	67	71	80	95,5	100	117	123	145	160
E	20	32	42	55	76	103	136	190	240
E <sub>max.</sub>	21	33	50	70	92	114	150	210	253
F	83	108	140	176	224	286	362	458	586
G	3xM8	3xM8	3xM10	3xM10	3xM12	3xM16	3xM16	6xM16	6xM16
H	56	56	69	85	90	130	130	190	190
J	22	21	28	32,5	40,6	46,5	47	55	55
K	8	9	10	11	12	14	17	19	19
R*	5,5	5,5	5,5	8	8	8	8	12	12
W	20	20	22,45	25,7	26,5	30	35	38	48
approx. kg	4	6	10	18	29	54	88	145	240

\* from Ø 200 hexagon

**Short taper mount**

**DIN 55021 with setscrews and nuts**



Size A	125		160		200		250				
Short-taper size	3	4	4	5	6	4	5	6	5	6	8
B	53,9	63,5	63,5	82,5	106,4	63,5	82,5	106,4	82,5	106,4	139,7
D	84	84	81	81	81	96,5	96,5	96,5	101	101	101
E	32	32	42	42	42	55	55	55	76	76	76
F	DIN Caml.	75 85	85 82,5	85 104,8	133,4	85 82,5	104,8	133,4	104,8	133,4	171,4
W	21	21	23,45	23,45	23,45	26,7	26,7	26,7	27,5	27,5	27,5
Mouting holes	DIN Caml.	3 3	3 3	4 6	4 6	3 3	4 6	4 6	4 6	4 6	4 6
approx. kg		6		10		19		30			

**DIN 55027 with studs and locknuts**

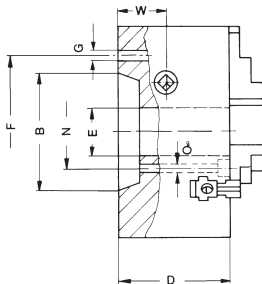

Size A	315		400		500		630		
Short-taper size	6	8	11	8	11	11	15	11	15
B	106,4	139,7	196,9	139,7	196,9	196,9	285,8	196,9	285,8
D	118	118	118	124	124	147	147	162	162
E	103	103	103	136	136	190	190	240	240
F	133,4	171,4	235	171,4	235	235	330,2	235	330,2
P	-	-	-	-	-	-	-	192,7	-
Q	-	-	-	-	-	-	-	88	-
W	31	31	31	36	36	40	40	50	50
Mouting holes	DIN Caml.	4 6	4 6	6 6	4 6	6 6	6 6	6 6	6 6
approx. kg		56		92		155		250	

**DIN 55029 with studs for camlock**

All other dimensions should be taken from the table on the top

**DIN 55026**

Mounting from front

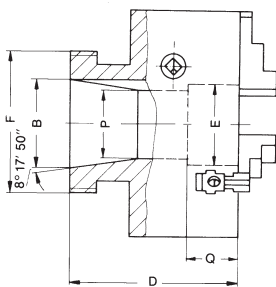

Size A	160	200	250	315	400	500	630				
Short-taper size	5	5	6	6	8	8	11	11	11	15	
B	82,5	82,5	106,4	106,4	139,7	106,4	139,7	139,7	196,9	196,9	285,8
D	81	96,5	96,5	101	101	118	118	124	124	147	162
E	42	42	55	55	76	103	76	136	125	190	190
F <sup>3)</sup>	-	-	-	-	-	133,4	-	171,4	-	235	235
G	-	-	-	-	-	14	-	18	-	22	22
N <sup>2)</sup>	61,9	61,9	82,6	82,6	111,1	-	111,1	-	165,1	-	247,6
O	11 <sup>1)</sup>	11 <sup>1)</sup>	14	14	18	-	18	-	22	-	26
W	23,45	26,7	26,7	27,5	27,5	31	31	36	36	40	50
Mouting holes	*	3	3	6	6	6	6	6	6	6	6
	**	4	4	4	4	4	4	4	8	8	8
approx. kg	10	19		30		56		92		154	250

1) 12 with ASA B 5.9 A1/A2 inch, all other dim. should be taken from the above table.

2) With DIN 55026 form B; ASA B 5.9 A1/B1

3) With DIN 55026 Form A and B; DIN 55021 Forme A and B; ASA B 5.9 A1/A2

\* 3-Jaw

\*\* 4-Jaw

## Jaws EG-ES

### Max. permissible speeds for chucks EG-ES to DIN 6351

The specified values are only applicable for workpieces not exceeding a specific unbalance of 25 gmm/kg.

Size	3-Jaw		4-Jaw	
	Cast iron body	Steel body	Cast iron body	Steel body
100	2900	-	2550	-
125	2650	-	2350	-
160	2150	3200	1900	2850
200	1750	2650	1550	2350
250	1450	2200	1280	1900
315	980	1400	800	1220
400	850	1400	750	1220
500	680	880	600	770
630	540	750	480	660

Reversible jaw UB

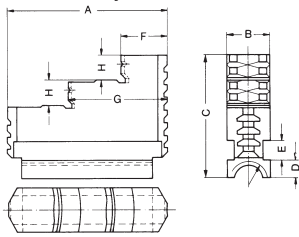

Left-hand thread

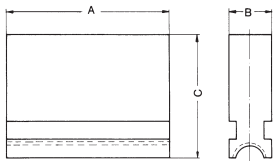

Size	100	125	160	200	250	315	400	500	630
A	56	56	69	85	90	130	130	190	190
B	18	18	20	24	24	34	34	42	42
C	41,5	41,5	50	57,5	67,5	79,5	79,5	95	95
D	8,7	8,7	9,7	9,7	9,7	11,15	11,15	15	15
E	7	7	8	10	10	15	15	15	15
F	17	17	19	25	26	40	40	50	50
G	35	35	43	54	56	85	85	120	120
H	8	8	10	12	14	15	15	20	20
Thread	Tr14x3	Tr14x3	Tr16x4	Tr18x2	Tr18x2	Tr20x2	Tr20x2	Tr26x3	Tr26x3
approx. kg	0,18	0,18	0,3	0,53	0,7	1,7	1,7	3,7	3,7



Three- and four-jaw chuck with cast iron body in the rational employment for positioning and carrying circular workpieces.

**Technical features:**

- cast iron body
- sizes 125 - 200: 4 setscrews for fine adjustment
- lathe chucks must be lubricated regularly to maintain their gripping force

**Delivery includes:**

- 1 set of outward stepped jaws (BB) mounted in the chuck
- 1 set of inward stepped jaws (DB)
- size 70 with reversible jaws
- fixing screws

Tool group A09  
Lever scroll chucks KRF  
cylindrical centre mount

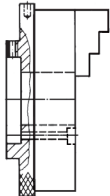

Size	ZA	Through-hole	3 jaw chuck with inside and outside jaw	4 jaw chuck with inside and outside jaw	Torque Nm	Total clamping force kN
70	48	16	148793 <sup>1)</sup> ●	148794 ■	12	2,5
110	75	26	148757 ●	148772 ■	26	3,2
125	70	35	150757 ●	150758 ■	36	3,5
160	78,5	52	150759 ●	150760 ■	50	4
200	115	64	150761 ●	150762 ■	60	4,5

<sup>1)</sup> jaws reversible  
sizes 125 - 200: 4 setscrews for fine adjustment

**Dimensions KRF**  
cylindrical centre mount

	A	B <sup>H6</sup>	C	D	F	3-jaws G	4-jaws G	H	J	K	M	Clamping range		Weight approx. kg	
												external	internal	3-jaws	4-jaws
70	48	1,5	33	39	3xM6	3xM6	32	13,6	52	72	2-70	23-70	1	1,4	
110	75	2	38	62	3xM8	3xM8	48	19	85	112	3-110	33-104	3	3,4	
125	70	8	53	56	3xØ6,6	4xØ6,6	52	22,5	83	129	3-125	37-123	4	4,5	
160	78,5	8	52	65	3xØ6,6	4xØ6,6	61	26,6	96	164	3-160	39-152	7	7,5	
200	115	13	66	84	3xØ9	4xØ9	69	31	147	205	4-200	44-186	13	14	

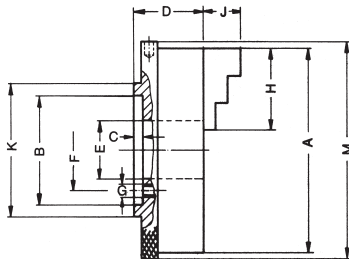

Size 70-100

4 setscrews for fine adjustment

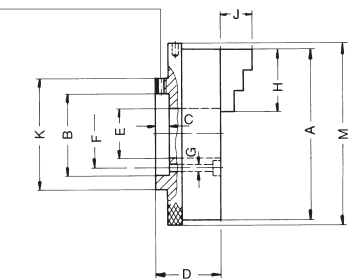

## KRF

Tool group A09  
Type 399-60 **6-jaw chuck, cast iron body**, with special jaws with fine adjustable centre mount, for grinding twist drills



Size	Through-hole	3 jaw chuck with inside and outside jaw	Torque Nm	Total clamping force kN
125	35	127920 ●	36	3,5
160	52	127921 ■	50	4
200	81	127922 ●	60	4,5
250	102	103648 ■	70	5

4 setscrews for fine adjustment

### Dimensions KRF

	A	Lathe chucks BH6	Spindle B1	C	D	F	G	H	J	K	M
125	70	69,5	8	50	56	3xØ6,6	48	37	83	129	
160	78,5	78	8	52	65	3xØ6,6	57	36	96	164	
200	115	114,5	13	66	97	6xØ9	85	82	147	205	
250	145	144,5	12	77	126	3xØ14	98	78	170	258	

4 setscrews for fine adjustment

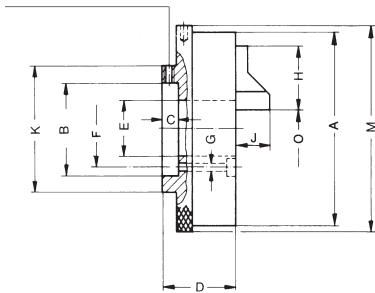

## KRF - on base plate

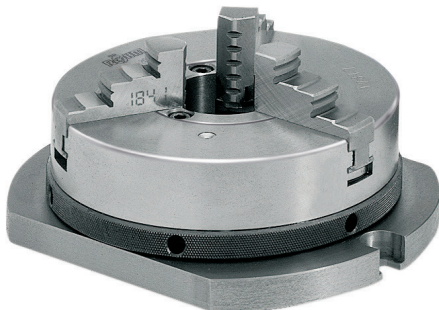

Three- and four-jaw chuck with cast iron body in the rational employment for positioning and carrying circular workpieces.

#### Technical features:

- cast iron body
- sizes 125 - 200: 4 setscrews for fine adjustment
- lathe chucks must be lubricated regularly to maintain their gripping force

#### Delivery includes:

- 1 set of outward stepped jaws (BB) mounted in the chuck
- 1 set of inward stepped jaws (DB)
- size 70 with reversible jaws
- fixing screws

Tool group A09  
Type 399-30 **Lever scroll chucks with base plate**  
**3-jaw-chuck cast iron body**

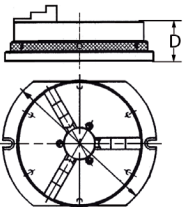

Item no.	Size	Through-hole	D	Torque Nm	Total clamping force kN
150595 <sup>1)</sup> ●	70	16	32,4	12	2,5
150596 ●	110	26	36	26	3,2
150597 ●	125	35	44	36	3,5
150598 ●	160	52	43	50	4
150599 ■	200	64	53	60	4,5

<sup>1)</sup> jaws reversible

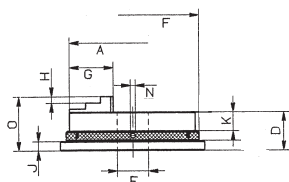

Size	A <sub>1</sub>	B	C	F	G	H	J	K	M	N	O	Clamping range	
												external	internal
70	100	70	87	72	32	5	13	21	9	6	60	2-70	23-70
110	140	110	126	112	48	6	13	23	9	8	67,5	3-110	33-104
125	170	125	154	129	52	8	14	32	11	8	81,5	3-125	37-123
160	200	160	184	164	61	10	15	31	11	8	85	3-160	39-152
200	250	200	230	205	69	10	15	39	11	8	100	4-200	44-186



# Jaws KRF

Tool group A09  
Type 300 **Inside jaw BB DIN 6350**  
outward stepped jaw, hardened

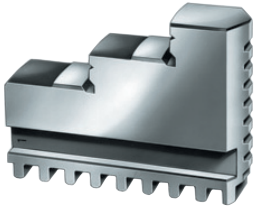

Chuck Size	3-jaw set	4-jaw set	Jaw length	Jaw height	Jaw width
74	110154 <sup>1)</sup> ●	149305 <sup>1)</sup> ▲	32	23	10
100/110	110156 ●	110064 ▲	48	33,5	14
125	110157 ●	110065 ●	52	41,5	18
160	110159 ●	110067 ●	61	47,5	18
200	110160 ●	110068 ●	69	53,5	20

<sup>1)</sup> reversible, for use as turning or inside jaws  
Stepped and hardened jaws, supplied as supplement or as spares, must be ground on the chuck.  
In case of a subsequent jaw delivery please return the chuck.

Tool group A09  
Type 300 **Outside jaw DB**  
**DIN 6350**  
inward stepped jaw, hardened

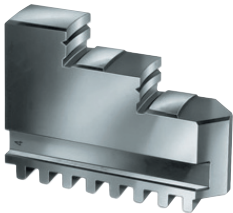

Chuck Size	3-jaw set	4-jaw set	Jaw length	Jaw height	Jaw width
100/110	110166 ●	110074 ▲	48	33,5	14
125	110167 ●	110075 ●	52	41,5	18
160	110169 ●	110077 ●	61	47,5	18
200	110170 ●	110078 ●	69	53,5	20

Stepped and hardened jaws, supplied as supplement or as spares, must be ground on the chuck.  
In case of a subsequent jaw delivery please return the chuck.

Tool group A09  
Type 301 **Unstepped jaw BL**  
**DIN 6350**  
unstepped, soft, 16MnCr5



Chuck Size	3-jaw set	4-jaw set	Jaw length	Jaw height	Jaw width
74	109114 <sup>1)</sup> ●	149304 <sup>1)</sup> ▲	32	23	10
100/110	107589 ●	107599 ●	48	33,5	14
125	107590 ●	107600 ●	52	41,5	18
160	107592 ●	107602 ●	61	47,5	18
200	107593 ●	107603 ●	69	53,5	20

<sup>1)</sup> jaws reversible

# Accessories KRF

Tool group A09

Type 304 **Unfinished adapter plates** for **cylindrical mount**. The unfinished back plate must be machined and fitted on both machine and chuck side

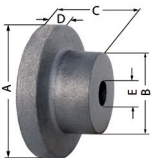

Item no.	Chuck Size	Inch	A	B	C	D	E
017123 ▲	74	3	80	56	45	15	-
017114 ●	100	4	120	80	58	20	25
017115 ●	125	5	135	80	58	20	25
017116 ●	160	6 ¼	170	80	58	20	30
017117 ●	200	8	210	92	66	22	40

Tool group A09

Type 300 **Chip guard, piece**



Item no.	Contents of delivery	Size
108501 ●	piece	100/110
108502 ●	piece	125
108503 ●	piece	140/160
108504 ●	piece	200

Tool group A09

Type 1028 **Special grease F80** for **lathe chucks**  
for lubrication and conservation of chucking power



Item no.	Design	Contents
028975 ●	Tin	1 kg



For turning unhardened jaws and grinding hardened jaws, with reversible and stepless adjustable setting jaws.

The BAV cutting attachment is mainly used for turning the inside and outside diameters of soft jaws on 3-jaw chucks.

It permits the chuck to be adjusted to the condition in which the work piece will be gripped within a few seconds (pretightening).

This assures positive gripping and accurate concentricity of the machined clamping surfaces of the chuck jaws in the tightened condition.

**Technical features:**

- only applicable with base jaws (GB) and top jaws (AB)

Tool group A09  
Type 091 Jaw cutting attachment  
for three-jaw chucks

Item no.	Size	For chuck size	Load max.	External Ø	Inner Ø	Overhang distance		B	Thread	Weight approx. kg
						Ø J	Ø A			
220206 <sup>1)</sup>	0	125	15	153	110	50-115	150-215	20	M5	1,6
220207	1	200	30	176	110	35-125	170-260	31	M8	3,4
220208	2	250	30	215	135	70-140	215-285	31	M8	5
220209	3	250	30	244	162	100-175	240-315	31	M8	5,7
220210	4	315	30	290	208	145-215	290-360	31	M8	6,9
220211	5	400	40	342	260	160-270	330-440	31	M10	8,5

<sup>1)</sup> light-duty design

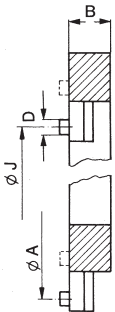

# Adapter plates

Tool group A09  
Type 619-25 **Short-taper adapter plate ISO 702-3** (DIN 55027) and 55022 with studs and locknuts

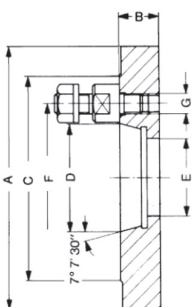

Item no.	Ø A	Taper	Inch	B	C	D	E	F	G	Weight approx. kg
319650	125	3	5	19	102	53,975	40	75	M10	2,3
319651	125	4	5	19	112	63,513	40	85	M10	2,2
319652	160	3	6 ¼	21	102	53,975	40	75	M10	3,9
319653	160	4	6 ¼	21	112	63,513	40	85	M10	3,9
319654	160	5	6 ¼	21	135	82,563	40	104,8	M10	4,6
319655	200	4	8	21	112	63,513	50	85	M10	6,4
319656	200	5	8	21	135	82,563	50	104,8	M10	7,4
319657	200	6	8	23	170	106,375	50	133,4	M12	8,4
319658	250	4	1	21	112	63,513	61	85	M10	10,2
319659	250	5	10	21	135	82,563	63	104,8	M10	11,6
319660	250	6	10	23	170	106,375	63	133,4	M12	13,3
319661	250	8	10	26	220	139,719	63	171,4	M16	13,8
319662	315	5	12 ¼	26	135	82,563	63	104,8	M10	18,6
319663	315	6	12 ¼	26	170	106,375	63	133,4	M12	21,5
319664	315	8	12 ¼	26	220	139,719	63	171,4	M16	22,6
319665	315	11	12 ¼	33	290	196,869	63	235	M20	25,2
319666	400	6	15 ¾	31	170	106,375	63	133,4	M12	35
319667	400	8	15,75	31	220	139,719	63	171,4	M16	37,2
319668	400	11	15,75	31	290	196,869	63	235	M20	42
319669	400	15	15,75	33	400	285,775	63	330,2	M24	42,1
319670	500	8	20	41	220	139,719	80	171,4	M16	62
319671	500	11	20	41	290	196,869	80	235	M20	67
319672	500	15	20	41	400	285,775	80	330,2	M24	68

Tool group A09  
Type 619-30 **Short-taper adapter plate ISO 702-1** (DIN 55026/55021) - **ASA B 5.9** (without mounting bolts) finished on machine side, faced on chuck side, especially

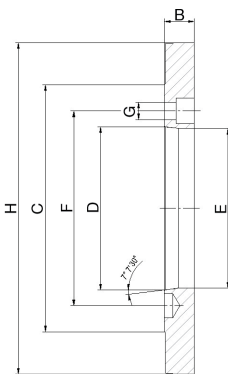

Item no.	Ø A	Spindle nose size	B	C	D	E	F	G
144933	125	3	18	-	53,975	40	70,6	3xØ10
145296	125	4	18	-	63,513	40	82,6	3xØ11
145328	160	3	18	-	53,975	40	70,6	3xØ10,5
145342	160	4	18	-	63,513	40	72,6	3xØ11
145343	160	5	21	-	82,563	50	104,8	3xØ11
145344	200	4	21	-	63,513	50	82,6	3xØ11
145345	200	5	21	-	82,563	50	104,8	3xØ11
145346	200	6	27	180	106,375	50	133,4	3xØ14
145347	250	4	27	-	63,513	63	82,6	3xØ11
145348	250	5	27	145	82,563	63	104,8	3xØ11
145349	250	6	27	181	106,375	63	133,4	3xØ14
145350	250	8	27	220	139,719	63	171,4	3xØ18
145351	315	5	36	145	82,563	63	104,8	3xØ11
145352	315	6	36	181	106,375	63	133,4	3xØ14
145353	315	8	36	220	139,719	63	171,4	3xØ18
145354	315	11	36	298	196,869	63	235	3xØ22
145355	400	6	40	181	106,375	63	133,4	3xØ14
145356	400	8	40	220	139,719	63	171,4	3xØ18
145357	400	11	40	298	196,869	63	235	3xØ22
145358	400	15	40	-	285,775	63	330,2	3xØ24
145359	500	8	42	227	139,719	80	171,4	3xØ18
145360	500	11	42	290	196,869	80	235	3xØ22
145364	500	15	42	400	285,775	80	330,2	3xØ24

Safety driving adapter plates available on request.

# Adapter plates

Tool group A09  
Type 324-50 **Short-taper adapter plate**  
for ISO 702-1 (DIN 55026), finished on both sides (without mounting bolts)

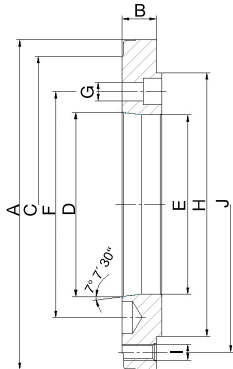

Item no.	Ø A	Taper	B	C	D	E	F	G	H	I	J
176804	125	3	17	102	53,975	51,2	70,6	3xø10,5	95	3x M8	108
176805	125	4	17	117	63,513	60,7	82,6	3x ø11	95	3x M8	108
176806	125	5	17	146	82,563	79,4	104,8	3x ø11	95	3x M8	108
176807	160	4	22	117	63,513	60,7	82,6	3x ø11	125	3x M10	140
176808	160	5	22,5	146	82,563	79,4	104,8	4x ø11	125	3x M10	140
176809	200	4	22,5	117	63,513	60,7	82,6	3x ø11	160	3x M10	176
176810	200	5	22,5	146	82,563	79,4	104,8	3x ø11	160	3x M10	176
176811	200	6	21,5	181	106,375	103	133,4	3x ø14	160	3x M10	176
176812	200	8	27	210	139,719	136	171,4	3x ø18	160	3x M10	176
176813	250	5	21	146	82,563	79,4	104,8	4x ø11	200	3x M12	224
176814	250	6	26	181	106,375	103	133,4	4x ø14	200	3x M12	224
176815	250	8	26	225	139,719	136	171,4	4x ø18	200	3x M12	224
176816	315	6	31,5	181	106,375	103	133,4	4x ø14	260	3x M12	286
176817	315	8	31	225	139,719	136	171,4	4x ø18	260	3x M12	286
176818	315	11	31	298	196,869	192,7	235	6x ø22	260	3x M12	286
176819	400	6	32,5	181	106,375	103	133,4	4x ø14	330	3x M16	362
176820	400	8	32	225	139,719	136	171,4	4x ø18	330	3x M16	362
176821	400	11	32,5	298	196,869	192,7	235	6x ø22	330	3x M16	362
176822	400	15	36	380	285,775	281,2	330,2	6x ø26	330	3x M16	362
176823	500	8	36	225	139,719	136	171,4	4x ø18	420	6x M16	458
176824	500	11	36	298	196,869	192,7	235	6x ø22	420	6x M16	458
176825	500	15	36	380	285,775	281,2	330,2	6x ø26	420	6x M16	458
159883	630	20	42	520	412,775	407,5	463,6	6x ø26	545	6x M16	586
176826	630	11	39	298	196,869	192,7	235	6x ø22	545	6x M16	586
176827	630	15	39	403	285,775	281,2	330,2	6x ø26	545	6x M16	586

Tool group A09  
Type 619-40 **Short-taper adapter plate**  
ISO 702-2 (DIN 55029) and ASA B 5.9 D1 Camlock

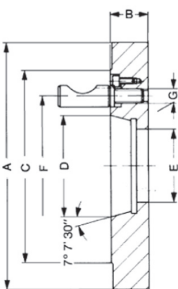

Item no.	Ø A	Taper	Inch	B	C	D	E	F	G	Weight approx. kg
319673	125	3	5	27	92,1	53,975	40	70,66	7/16 - 20	2,3
319674	125	4	5	28	117,5	63,513	40	82,55	7/16 - 20	2,2
319675	160	3	6 ¼	27	92,1	53,975	40	70,66	7/16 - 20	3,9
319676	160	4	6 ¼	28	117,5	63,513	40	82,55	7/16 - 20	3,9
319677	160	5	6 ¼	31	146	82,563	40	104,8	½ - 20	4,6
319678	200	4	8	28	117,5	63,513	50	82,55	7/16 - 20	6,4
319679	200	5	8	31	146	82,563	50	104,8	½ - 20	7,4
319680	200	6	8	36	181	106,375	50	133,4	5/8 - 18	8,4
319681	250	4	1	28	117,5	63,513	61	82,55	7/16 - 20	10,2
319682	250	5	10	31	146	82,563	63	104,8	½ - 20	11,6
319683	250	6	10	36	181	106,375	63	133,4	5/8 - 18	13,3
319684	250	8	10	39	225,4	139,719	63	171,4	¾ - 16	13,8
319685	315	5	12 ¼	31	146	82,563	63	104,8	½ - 20	18,6
319686	315	6	12 ¼	36	181	106,375	63	133,4	5/8 - 18	21,5
319687	315	8	12 ¼	39	225,4	139,719	63	171,4	¾ - 16	22,6
319688	315	11	12 ¼	45	298,4	196,869	63	235	7/8 - 14	25,2
319689	400	6	15 ¾	36	181	106,375	63	133,4	5/8 - 18	35
319690	400	8	15,75	39	225,4	139,719	63	171,4	¾ - 16	37,2
319691	400	11	15,75	45	298,4	196,869	63	235	7/8 - 14	42
319692	400	15	15,75	50	403	285,775	63	330,2	1 - 14	42,1
319693	500	8	20	41	225,4	139,719	80	171,4	¾ - 16	62
319694	500	11	20	45	298,4	196,869	80	235	7/8 - 14	67
319695	500	15	20	50	403	285,775	80	330,2	1 - 14	68

Safety driving adapter plates available on request.

# Steel / Cast iron body Independent chucks

**Independent 4-jaw chucks - Jaws individually adjustable through threaded adjusting spindle.**

RÖHM-Independent chucks in steel or cast iron design with individually adjustable jaws are successfully established, where irregular, regular or round workpieces have to be clamped safely.

**Mechanism**

By turning the radial positioned pinion (2, hardened) the power will be transmitted to the clamping jaws (5, 6, hardened) directly. The operating screw will be kept in position by the bearing support (3, 4, hardened). Steel or cast iron body (1)

**Lubrication**

Independent chucks must be lubricated regularly to maintain their gripping force. Appropriate directions are included in the operating instructions supplied with each chuck.

Independent chucks

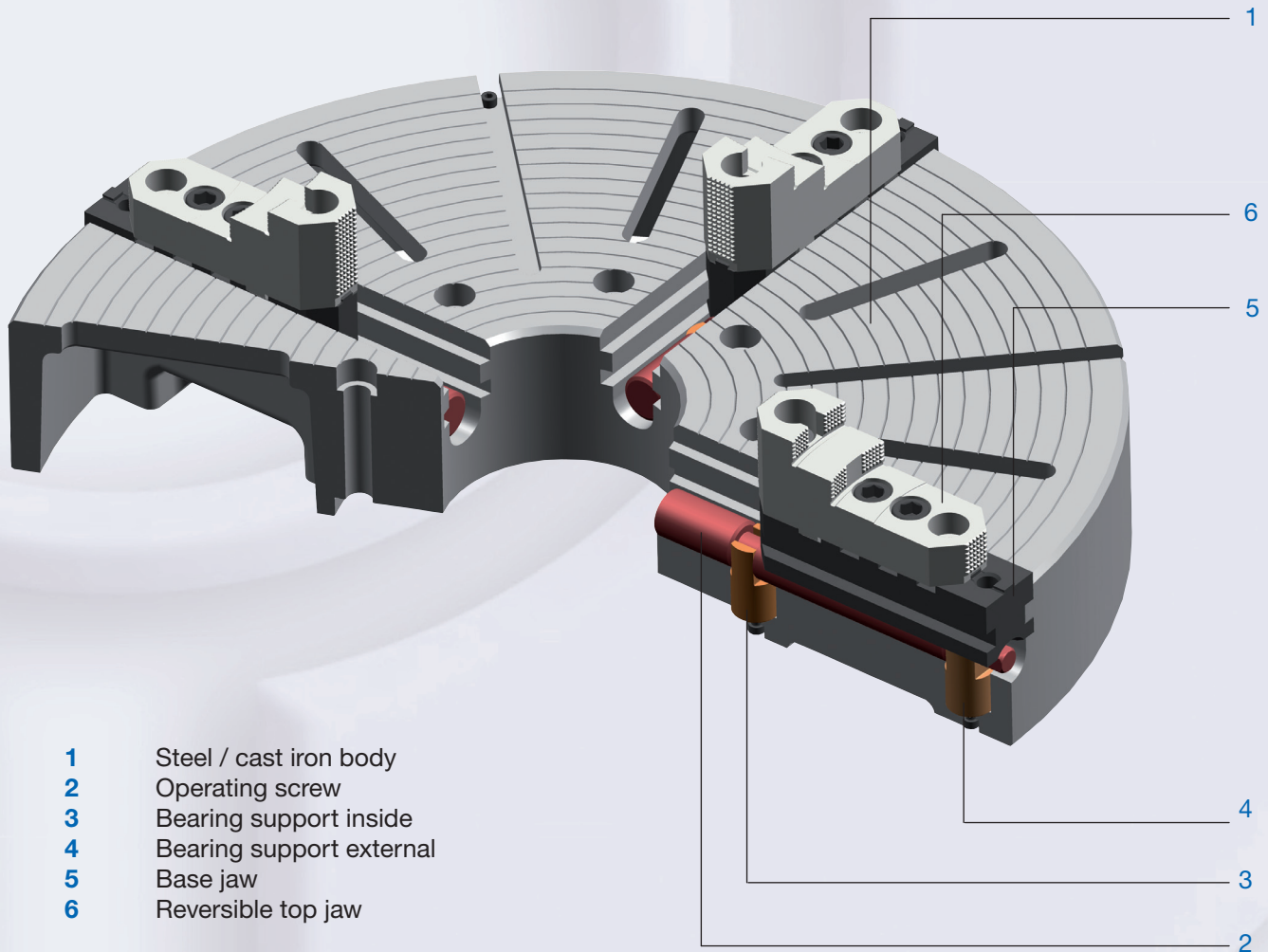

- 1 Steel / cast iron body
- 2 Operating screw
- 3 Bearing support inside
- 4 Bearing support external
- 5 Base jaw
- 6 Reversible top jaw



**USE-USU**



The jaws can be centered approximately by adjusting them to the concentric grooves, accurate centering requires the use of a dial indicator.

Independent 4-jaw chuck

**Technical features:**

- jaws individually adjustable through threaded adjusting spindle
- steel version, from size 400 with T-slots and bolt slots

**Delivery includes:**

- 1 set of hard solid reversible jaws,
- 1 wrench,
- mounting screws

or

- 1 set of hard master jaws,
- 1 set of hard top jaws,
- 1 wrench,
- mounting screws

Tool group A26  
Steel independent chucks  
**cylindrical centre mount** (without mounting bolts)

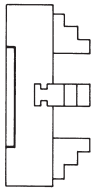

Size	Through-hole	with one-piece reversible jaws	with reversible top jaws	Speed max. min <sup>-1</sup>	Torque Nm	Clamping force/jaw kN
260	70	139781 ■	137147 ■	2350	120	17
310	75	139796 ■	139720 ■	1970	120	17
400	95	139827 ■	135368 ■	1530	170	23
450	95	139842 ■	136944 ■	1360	170	23
500	95	139857 ■	135631 ■	1220	170	23
630	135	139887 ■	139723 ■	970	240	37
710	135	140800 ■	141097 ■	860	240	37
800	190	140801 ■	141106 ■	765	300	45

Tool group A26  
Steel independent chucks  
**ISO 702-3** (DIN 55027), DIN 55022;  
with studs and locknuts, optional  
DIN 55021 with set screw and nut

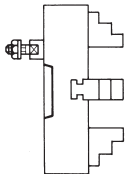

Size	Mount short taper	Through-hole	with one-piece reversible jaws	with reversible top jaws	Speed max. min <sup>-1</sup>	Torque Nm	Clamping force/jaw kN
260	4	61	139782 ▲	137163 ▲	2350	120	17
260	5	70	139783 ▲	137164 ▲	2350	120	17
260	6	70	139784 ▲	137165 ▲	2350	120	17
310	5	75	139797 ▲	139724 ▲	1970	120	17
310	6	75	139798 ▲	139725 ▲	1970	120	17
310	8	75	139799 ▲	139726 ▲	1970	120	17
400	6	95	139828 ▲	135371 ▲	1530	170	23
400	8	95	139829 ■	135372 ▲	1530	170	23
400	11	95	139830 ▲	135358 ▲	1530	170	23
450	6	95	139843 ■	136947 ▲	1360	170	23
450	8	95	139844 ▲	136948 ▲	1360	170	23
450	11	95	139845 ▲	136957 ▲	1360	170	23
500	6	95	139858 ▲	135632 ▲	1220	170	23
500	8	95	139859 ■	135633 ▲	1220	170	23
500	11	95	139860 ▲	135696 ▲	1220	170	23
630	8	136	139888 ▲	139767 ▲	970	240	37
630	11	136	139889 ▲	139768 ▲	970	240	37
630	15	136	139890 ▲	139769 ▲	970	240	37
710	8	136	141088 ▲	141098 ▲	860	240	37
710	11	136	141089 ▲	141099 ▲	860	240	37
800	8	200	141092 ▲	141414 ▲	765	300	45
800	11	192	141093 ▲	600638 ▲	765	300	45
800	15	192	141094 ▲	141107 ▲	765	300	45
900	11	190	-	600639 ▲	680	300	45
900	15	190	-	600641 ▲	680	300	45
1000	11	190	-	141115 ▲	610	320	47
1000	15	190	-	141116 ▲	610	320	47
1000	20	190	-	600645 ▲	610	320	47
1100	11	190	-	150500 ▲	555	320	47
1100	15	190	-	600642 ▲	555	320	47
1100	20	190	-	600646 ▲	555	320	47
1200	11	190	-	150501 ▲	510	450	64
1200	15	190	-	600643 ▲	510	450	64
1200	20	190	-	600647 ▲	510	450	64

## USE-USU

Tool group A26  
Steel independent chucks  
**ISO 702-1 (DIN 55026)**; DIN 55021, ASA B 5.9, A1/A2 metr.; mounting from front (without mounting bolts)

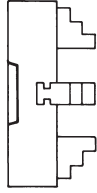

Size	Mount short taper	Through-hole	with one-piece reversible jaws	with reversible top jaws	Speed max. min <sup>-1</sup>	Torque Nm	Clamping force/jaw kN
260	4	61	139785 <sup>1)</sup> ■	137260 ▲	2350	120	17
260	5	70	139786 <sup>2)</sup> ■	137261 ▲	2350	120	17
260	6	70	139787 ▲	137262 ▲	2350	120	17
310	5	75	139800 <sup>2)</sup> ■	139727 ▲	1970	120	17
310	6	75	139801 ▲	139728 ▲	1970	120	17
310	8	75	139802 ▲	139729 ▲	1970	120	17
400	6	95	139831 ▲	135373 ▲	1530	170	23
400	8	95	139832 ▲	135374 ▲	1530	170	23
400	11	95	139833 ▲	135360 ▲	1530	170	23
450	6	95	139846 ▲	136949 ▲	1360	170	23
450	8	95	139847 ▲	136950 ▲	1360	170	23
450	11	95	139848 ▲	136956 ▲	1360	170	23
500	6	95	139861 ▲	135700 ▲	1220	170	23
500	8	95	139862 ▲	135701 ▲	1220	170	23
500	11	95	139863 ▲	135702 ▲	1220	170	23
630	8	136	139891 ▲	139770 ▲	970	240	37
630	11	136	139892 ▲	139771 ▲	970	240	37
630	15	136	139893 ▲	139772 ▲	970	240	37
710	8	136	141090 ▲	141100 ▲	860	240	37
710	11	136	141091 ▲	141101 ▲	860	240	37
800	11	192	141095 ▲	141415 ▲	765	300	45
800	15	192	141096 ▲	600648 ▲	765	300	45
900	11	190	-	600650 ▲	600	300	45
900	15	190	-	600651 ▲	680	300	45
1000	11	190	-	141117 ▲	610	320	47
1000	15	190	-	141118 ▲	610	320	47
1000	20	190	-	600655 ▲	610	320	47
1100	11	190	-	150502 ▲	555	320	47
1100	15	190	-	600652 ▲	555	320	47
1100	20	190	-	600656 ▲	555	320	47
1200	11	190	-	150503 ▲	510	450	64
1200	15	190	-	600653 ▲	510	450	64
1200	20	190	-	600657 ▲	510	450	64

<sup>1)</sup> not for DIN 55021 or A1/A2 inch

<sup>2)</sup> not for A1/A2 inch

Tool group A26  
Steel independent chucks  
**ISO 702-2 (DIN 55029)**; ASA B 5.9, Type D, with studs for Camlock

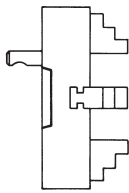

Size	Mount short taper	Through-hole	with one-piece reversible jaws	with reversible top jaws	Speed max. min <sup>-1</sup>	Torque Nm	Clamping force/jaw kN
260	4	60	139791 ▲	137166 ▲	2350	120	17
260	5	70	139792 ▲	137254 ▲	2350	120	17
260	6	70	139793 ▲	137255 ▲	2350	120	17
310	5	75	139806 ▲	139733 ▲	1970	120	17
310	6	75	139807 ▲	139734 ▲	1970	120	17
310	8	75	139808 ▲	139735 ▲	1970	120	17
400	6	95	139837 ▲	135375 ▲	1530	170	23
400	8	95	139838 ▲	135376 ▲	1530	170	23
400	11	95	139839 ▲	135359 ▲	1530	170	23
450	6	95	139852 ▲	136951 ▲	1360	170	23
450	8	95	139853 ▲	136952 ▲	1360	170	23
450	11	95	139854 ▲	136955 ▲	1360	170	23
500	6	95	139867 ▲	135703 ▲	1220	170	23
500	8	95	139868 ▲	135704 ▲	1220	170	23
500	11	95	139869 ▲	135705 ▲	1220	170	23
630	8	136	139897 ▲	139776 ▲	970	240	37
630	11	136	139898 ▲	139777 ▲	970	240	37
630	15	136	139899 ▲	139778 ▲	970	240	37
710	8	136	140804 ▲	141102 ▲	860	240	37
710	11	136	140805 ▲	141103 ▲	860	240	37
710	15	136	-	141418 ▲	860	240	37
800	11	192	140810 ▲	141418 ▲	765	300	45
800	15	192	140811 ▲	600658 ▲	765	300	45
900	11	190	-	600660 ▲	680	300	45
900	15	190	-	600661 ▲	680	300	45
1000	11	190	-	141119 ▲	610	320	47
1000	15	190	-	141120 ▲	610	320	47
1000	20	190	-	600665 ▲	610	320	47
1100	11	190	-	150504 ▲	555	320	47
1100	15	190	-	600662 ▲	555	320	47
1100	20	190	-	600666 ▲	555	320	47
1200	11	190	-	150505 ▲	510	450	64
1200	15	190	-	600663 ▲	510	450	64
1200	20	190	-	600667 ▲	510	450	64

# Jaws USE-USU

Tool group A09  
Type 493 **Reversible jaw EB**  
hardened

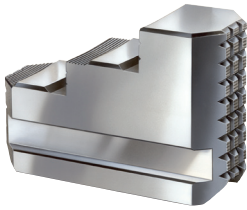

Item no.	Chuck Size	Number of jaws	Jaw length	Jaw height	Jaw width
022985 ■	260	4	85	64	35
022986 ■	310	4	94	66	35
163108 ■	400/450	4	112	80	40
163109 ■	500	4	136	88	40
175358 ■	630/710	4	172	108	45
247823 ■	800	4	185	130	60

Tool group A09  
Type 497 **Base jaw GB**  
with fixing screw

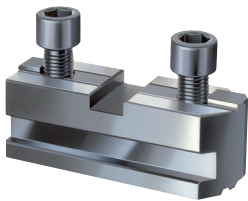

Item no.	Chuck Size	Number of jaws	Jaw length	Jaw height	Jaw width
304656 ■	260	4	91	40,1	35
304657 ■	310	4	107	40,1	35
304658 ■	400/450	4	126	47,1	40
304659 ■	500	4	164,4	47,1	40
304660 ■	630	4	165	51,1	45
304661 ■	710	4	202	51,1	45
304662 ■	800	4	240	61,1	60
150543 ▲	1200	4	350	92,2	70

Tool group A09  
Type 403 **Reversible top jaws UB**  
**DIN 6350**  
hardened

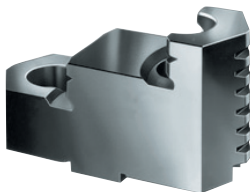

Item no.	Chuck Size	Number of jaws	Jaw length	Jaw height	Jaw width
108057 ■	260	4	95,3	52,5	36
108058 ■	310	4	109,5	57,5	42
108059 ■	400/450	4	127	64,5	42
108060 ■	500/630/710	4	127	79,5	50
105085 ■	800/900	4	210	89	68
105101 ■	1000/1100/1200	4	210	110	68

Stepped and hardened jaws, supplied as supplement or as spares, must be ground on the chuck.  
In case of a subsequent jaw delivery please return the chuck.

Tool group A09  
Type 402 **Unstepped top jaw AB**  
**DIN 6350**  
soft, material 16MnCr5



Item no.	Chuck Size	Number of jaws	Jaw length	Jaw height	Jaw width
107579 ●	260	4	103	53	36,5
107580 ●	310	4	120	58	42,5
107581 ●	400/450	4	137	65	42,5
107582 ●	500/630/710	4	140	80	50,5
105105 ■	800/900	4	210	89	68
105109 ■	1000/1100/1200	4	210	110	68

## Accessories USE-USU

Tool group A26  
Type 493 **Adjusting spindle**



Item no.	Size	Square	Hexagon
169142 <span style="color: yellow;">■</span>	260	10	-
166565 <span style="color: green;">●</span>	310	10	-
162110 <span style="color: yellow;">■</span>	400	13	-
162121 <span style="color: yellow;">■</span>	450	13	-
161629 <span style="color: green;">●</span>	500	13	-
161611 <span style="color: green;">●</span>	630	16	-
247826 <span style="color: green;">●</span>	800	18	-
150544 <span style="color: green;">●</span>	900	18	-
150545 <span style="color: green;">●</span>	1000	18	-
150546 <span style="color: yellow;">■</span>	1100	18	-
149776 <span style="color: yellow;">■</span>	1200	-	24

Tool group A26  
Type 493 **Safety key**



Item no.	Size	Square	Hexagon
160096 <span style="color: green;">●</span>	260/310	10	-
160097 <span style="color: green;">●</span>	400	13	-
160098 <span style="color: green;">●</span>	450/500	13	-
160099 <span style="color: green;">●</span>	630/710	16	-
160100 <span style="color: green;">●</span>	800/900/1000/1100	18	-
150548 <span style="color: yellow;">■</span>	1200	-	24

# Chuck dimensions steel body

## Cylindrical centre mount

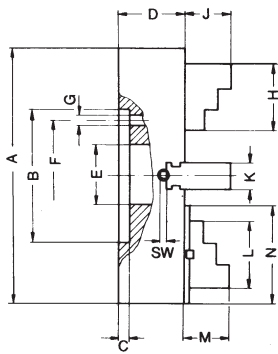

Size A	260	310	400	450	500	630	710	800	900	1000	1100	1200
B <sup>H8</sup>	130	130	210	210	210	260	260	370	370	370	370	550
C	8	8	18	18	18	18	18	18	18	18	18	18
D USE-USU	85	95	112,5	112,5	112,5	122,5	132,5	145	145	160	160	200
E USE-USU	70	75	95	95	95	135	135	180	190	190	190	190
F	105	105	175	175	175	220	220	330	330	330	330	500
G	4x13,5	4x13,5	4x17	4x17	4x17	4x20,5	4x20,5	8x22	8x22	8x22	8x22	8x26
H	85	94	112	112	136	172	172	185	-	-	-	-
J	34	35	42	42	50	55,5	55,5	80	-	-	-	-
K	35	35	40	40	40	45	45	60	60	60	60	70
L	80	87	105	114	126	140	165	210	210	210	210	210
M	54	57	72	72	77	82	87	91	91	111	111	111
N	100	105	125	135	145	165	185	240	240	240	240	350
SW	10	10	13	13	13	16	16	18	18	18	18	24 <sup>1)</sup>
approx. kg	23	32	52	76	91	150	190	270	300	395	750	900

1) Outer hexagon

## Short taper mount

### DIN 55021 with setscrews and locknuts



Size A	260			310			400			450			500			630			
Taper size	4 <sup>1)</sup>	5 <sup>2)</sup>	6	5	6	8	6	8	11	6	8	11	6	8	11	8	11	15	
B	63,5	82,5	106,4	82,5	106,4	139,7	106,4	139,7	196,9	106,4	139,7	196,9	106,4	139,7	196,9	139,7	196,9	285,8	
D	75			82			112,5			112,5			122,5			122,5			
E	61	70	70	75			95			95			95			135			
F	DIN Camlock	85 104,8	133,4	104,8	133,4	171,4	133,4	171,4	235	133,4	171,4	235	133,4	171,4	235	171,4	235	330,2	
G	11	11	14	11	14	18	14	18	22	14	18	22	14	18	22	18	22	26	
H	85			94			112			112			136			172			
J	34			35			42			42			50			55,5			
K	USE	35			35			40			40			40			45		
	USU	36			42			42			42			50			50		
L	95,3			109,5			127			127			127			127			
M	56,5			60,5			54			54			69			69			
N	91			107			126			126			164,4			165			
SW	10			10			13			13			13			16			
approx. kg	23			32			52			76			91			150			

### DIN 55027 with studs and nuts

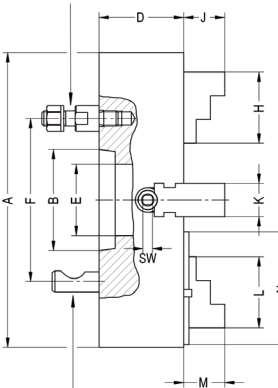

Size A	710			800			900			1000			1100			1200			
Taper size	8	11	15	8	11	15	11	15	11	15	20	11	15	20	11	15	20		
B	139,7	196,9	285,8	139,7	196,9	285,8	196,9	285,8	196,9	285,8	412,8	196,9	285,8	412,8	196,9	285,8	412,8		
D	132,5			145			145			160			160			200			
E	135			180			190			190			190			190			
F	171,4	235	330,2	171,4	235	330,2	235	330,2	235	330,2	463,6	235	330,2	463,6	235	330,2	463,6		
G	18	22	26	18	22	16	22	26	22	26	26	22	26	26	22	26	26		
H	172			185			-			-			-			-			
J	55,5			80			-			-			-			-			
K	USE	45			60			60			60			60			70		
	USU	68			68			68			68			68			68		
L	210			210			210			210			210			210			
M	69			91			91			112			112			112			
N	202			240			240			240			240			350			
SW	16			18			18			18			18			24			
approx. kg	190			270			300			395			750			900			

### DIN 55029 with studs for camlock

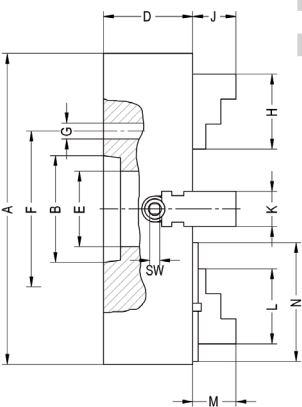

### DIN 55026 mounting from front

- 1) Not for DIN 55021 or A1/A2 inch
- 2) Not for A1/A2 inch



# Jaw dimensions steel body

## Reversible one-piece jaw EB

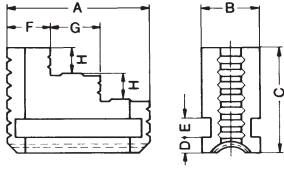

Size	260	310	400	450	500	630	710	800
A	85	94	112		136		172	185
B	35	35	40		40		45	60
C	64	66	80		88		108	130
D	10	10	10		10		12	14
E	12	12	14		14		14	18
F	27	30	36		42		52	55
G	29	32	38		46		60	65
H	14	15	19		23		26	30
approx. kg	0,8	0,9	1,6		2,25		3,5	4,2

## Base jaw GB

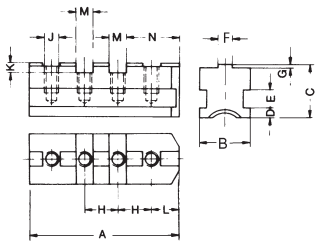

Size	260	310	400	450	630	710	800	900	1000	1100	1200
A	91	107	126		165	202		240			350
B	35	35	40		45	45		60			70
C	40,1	40,1	47,1		51,1	51,1		61,1			92,2
D	10	10	10		12	12		14			13
E	12	12	14		14	14		18			30
F	12,7	12,7	12,7		12,7	12,7		12,7			12,7
G	3,1	3,1	3,1		3,1	3,1		3,1			3,1
H	54	63,5	76,2		38,1	38,1		38,1			38,1
J	M12	M12	M16		M20	M20		M20			M20
K	7,6	7,6	10,8		10,8	10,8		10,8			10,8
L	21,2	24,4	27,5		27,5	27,5		27,5			26,4
M	19,03	19,03	19,03		19,03	19,03		19,03			19,03
N	38,7	46,6	56,1		56,1	56,1		56,1			55
Grooves	1	1	1		2	3		4			4
Tapped holes	2	2	2		4	5		6			9
approx. kg	0,8	0,9	1,1		1,4	2,2		2,8			3,5

Reversible top jaw UB and unstepped top jaw

## Adjusting spindle

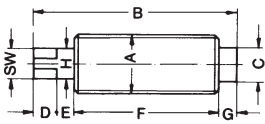

Size	260	310	400	450	500	630	710	800	900	1000	1100	1200
A	26	26	30		30	34	34	40	40	40	40	48
B	83,5	99	129		167	200	200	240	290	323	372	425
C	14	14	16		16	28	28	33	33	33	33	-
D	13	15	16		16	20,5	20,5	24	24	24	24	35
E	13,5	15	18,5		18,5	21,5	21,5	24	24	24	24	30
F	45	55	78		116	143	143	172	222	265	305	360
G	12	14	16,5		16,5	13,5	13,5	20	20	20	20	-
H	14	14	16		16	20	20	22	22	22	22	28
SW	10	10	13		13	16	16	18	18	18	18	24 <sup>1)</sup>

<sup>1)</sup> with outer hexagon

## Chucking capacities of jaw steps (standard values)

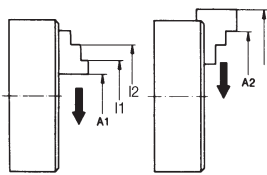

Size mm	260	310	400	450	500	630	710	800	900	1000	1100	1200
A1 min.	20	20	35	40	40	60	130	190	190	200	210	220
A2 max.	260	295	400	450	500	585	690	800	900	1000	1100	1200
I1 min.	75	80	90	100	145	145	145	170	170	195	195	195
I2 max.	260	310	400	450	520	650	730	820	960	1065	1165	1270
max. swing. dia.	305	355	465	510	570	675	785	870	1020	1120	1220	1320

## UGE-UGU



The jaws can be centered approximately by adjusting them to the concentric grooves, accurate centering requires the use of a dial indicator.  
Independent 4-jaw chuck

**Technical features:**

- jaws individually adjustable through threaded adjusting spindle

**Delivery includes:**

- 1 set of hard solid reversible jaws,
- 1 wrench,
- mounting screws

**or**

- 1 set of hard master jaws,
- 1 set of hard top jaws, 1 wrench,
- mounting screws

Tool group A26  
Cast iron independent chucks  
cylindrical centre mount (without mounting bolts)

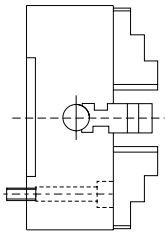

Size	Through-hole	with one-piece reversible jaws	with reversible top jaws	Speed max. min <sup>-1</sup>
160	45	1189704 ■	-	2000
200	56	1189705 ■	1189780 ■	1800
250	65	1189706 ■	1189781 ■	1500
315	80	1189707 ■	1189782 ■	1200
400	100	1189708 ■	1189783 ■	800
500	125	1189709 ■	1189784 ■	500
630	160	1189710 ■	1189785 ■	400
800	210	1189711 ■	1189786 ■	300
1000	260	1189712 ▲	1189787 ▲	200
1250	305	1189713 ▲	1189788 ▲	150

Tool group A26  
Cast iron independent chucks  
ISO 702-3 (DIN 55027), DIN 55022;  
with studs and locknuts, optional  
DIN 55021 with set screw and nut

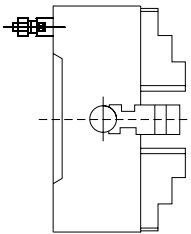

Size	Mount short taper	Through-hole	with one-piece reversible jaws	with reversible top jaws	Speed max. min <sup>-1</sup>
200	5	56	1189714 ■	1189789 ■	1800
200	6	56	1189715 ■	1189790 ■	1800
250	5	65	1189716 ■	1189791 ■	1500
250	6	65	1189717 ■	1189792 ■	1500
250	8	65	1189718 ■	1189793 ■	1500
315	5	80	1189719 ■	1189794 ■	1200
315	6	80	1189720 ■	1189795 ■	1200
315	8	80	1189721 ■	1189796 ■	1200
400	6	100	1189722 ■	1189797 ■	800
400	8	100	1189723 ■	1189798 ■	800
400	11	100	1189724 ■	1189799 ■	800
500	6	100	1189725 ■	1189800 ■	500
500	8	125	1189726 ■	1189801 ■	500
500	11	125	1189727 ■	1189802 ■	500
630	8	125	1189728 ■	1189803 ■	400
630	11	160	1189729 ■	1189804 ■	400
630	15	160	1189730 ■	1189805 ■	400
800	11	180	1189731 ■	1189806 ■	300
800	15	200	1189732 ■	1189807 ■	300
1000	11	190	1189858 ▲	1189808 ▲	200
1000	15	190	1189859 ▲	1189809 ▲	200
1250	11	190	1189860 ▲	1189810 ▲	150
1250	15	190	1189861 ▲	1189811 ▲	150

## UGE-UGU

Tool group A26  
**ISO 702-1 (DIN 55026)**; DIN 55021, ASA B 5.9, A1/A2 metr.; mounting from front (without mounting bolts)

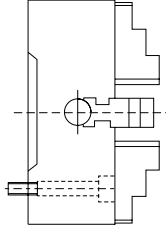

Size	Mount short taper	Through-hole	with one-piece reversible jaws	with reversible top jaws	Speed max. min <sup>-1</sup>
200	5	50	1189757 ■	1189835 ■	1800
200	6	50	1189758 ■	1189836 ■	1800
250	5	65	1189759 ■	1189837 ■	1500
250	6	65	1189760 ■	1189838 ■	1500
250	8	65	1189761 ■	1189839 ■	1500
315	5	80	1189762 ■	1189840 ■	1200
315	6	80	1189763 ■	1189841 ■	1200
315	8	80	1189764 ■	1189842 ■	1200
400	6	100	1189765 ■	1189843 ■	800
400	8	100	1189766 ■	1189844 ■	800
400	11	100	1189767 ■	1189845 ■	800
500	6	100	1189768 ■	1189846 ■	500
500	8	125	1189769 ■	1189847 ■	500
500	11	125	1189770 ■	1189848 ■	500
630	8	125	1189771 ■	1189849 ■	400
630	11	160	1189772 ■	1189850 ■	400
630	15	160	1189773 ■	1189851 ■	400
800	11	180	1189774 ■	1189852 ■	300
800	15	180	1189775 ■	1189853 ■	300
1000	11	180	1189776 ▲	1189854 ▲	200
1000	15	190	1189777 ▲	1189855 ▲	200
1250	11	190	1189778 ▲	1189856 ▲	150
1250	15	190	1189779 ▲	1189857 ▲	150

Tool group A26  
**Cast iron independent chucks ISO 702-2 (DIN 55029)**; ASA B 5.9, Type D, with studs for Camlock

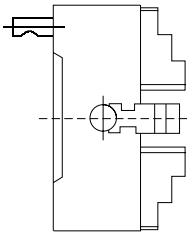

Size	Mount short taper	Through-hole	with one-piece reversible jaws	with reversible top jaws	Speed max. min <sup>-1</sup>
200	4	56	1189733 ■	1189812 ■	1800
200	5	56	1189734 ■	1189813 ■	1800
200	6	56	1189735 ■	1189943 ■	1800
250	4	60	1189736 ■	1189814 ■	1500
250	5	65	1189737 ■	1189815 ■	1500
250	6	65	1189738 ■	1189816 ■	1500
250	8	65	1189739 ■	1189817 ■	1500
315	5	80	1189740 ■	1189818 ■	1200
315	6	80	1189741 ■	1189819 ■	1200
315	8	80	1189742 ■	1189820 ■	1200
400	6	100	1189743 ■	1189821 ■	800
400	8	100	1189744 ■	1189822 ■	800
400	11	100	1189745 ■	1189823 ■	800
500	8	125	1189746 ■	1189824 ■	500
500	11	125	1189747 ■	1189825 ■	500
630	8	125	1189748 ■	1189826 ■	400
630	11	160	1189749 ■	1189827 ■	400
630	15	160	1189750 ■	1189828 ■	400
800	11	180	1189751 ■	1189829 ■	300
800	15	200	1189752 ■	1189830 ■	300
1000	11	180	1189753 ▲	1189831 ▲	200
1000	15	190	1189754 ▲	1189832 ▲	200
1250	11	190	1189755 ▲	1189833 ▲	150
1250	15	190	1189756 ▲	1189834 ▲	150

## Jaws UGE-UGU

Tool group A09  
Type 493-00 **Reversible jaw EB**  
hardened

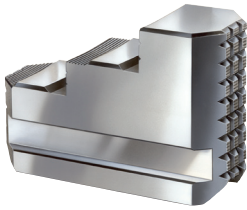

Item no.	Chuck Size	Number of jaws	Jaw length	Jaw height	Jaw width
1189865 ■	160	4	61,5	51	20
1189866 ■	200	4	85	61,5	27
1189867 ■	250	4	92	61,5	27
1189868 ■	315	4	111	76,5	40
1189871 ■	400	4	129	76,5	40
1189872 ■	500	4	152,5	93,5	52
1189873 ■	630	4	177	100,5	52
1189874 ■	800	4	202	114,5	70
1189875 ▲	1000/1250	4	245	150	80

Tool group A09  
Type 497-00 **Base jaw GB**  
with mounting bolts

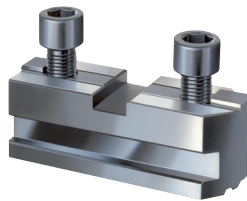

Item no.	Chuck Size	Number of jaws	Jaw length	Jaw height	Jaw width
1189895 ■	200	4	79	32	27
1189896 ■	250	4	94	38	27
1189897 ■	315	4	110	39	40
1189898 ■	400	4	129	44	40
1189899 ■	500	4	168	59	52
1189900 ■	630	4	206	59	52
1189901 ▲	800	4	206	59	70
1189902 ▲	1000/1250	4	305	76	80

Tool group A09  
Type 402 **Unstepped top jaw AB**  
soft



Item no.	Chuck Size	Number of jaws	Jaw length	Jaw height	Jaw width
1189877 ■	200	4	90	43,5	40
1189878 ■	250	4	106	51,5	47
1189879 ■	315	4	120	55	52
1189880 ■	400	4	140	64,5	52
1189881 ■	500	4	145	82	60
1189882 ■	630	4	145	82	60
1189883 ▲	800	4	145	85	80
1189884 ▲	1000/1250	4	170	102	85

Tool group A09  
Type 403 **Reversible top jaws UB**  
hardened

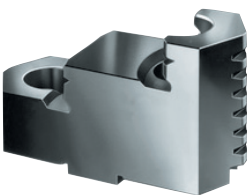

Item no.	Chuck Size	Number of jaws	Jaw length	Jaw height	Jaw width
1189886 ■	200	4	82	43,5	34
1189887 ■	250	4	96,5	51,5	34
1189888 ■	315	4	112,5	55	42
1189889 ■	400	4	129	64,5	42
1189890 ■	500	4	136	74,5	54
1189891 ■	630	4	136	82	54
1189892 ■	800	4	136	88	72
1189893 ■	1000/1250	4	160	102	82

## Accessories UGE-UGU

Tool group A26

Type 493 **Adjusting spindle**



Item no.	Size
1189920 <span style="color: yellow;">■</span>	160
1189921 <span style="color: yellow;">■</span>	200
1189922 <span style="color: yellow;">■</span>	250
1189923 <span style="color: yellow;">■</span>	315
1189924 <span style="color: yellow;">■</span>	400
1189925 <span style="color: yellow;">■</span>	500
1189926 <span style="color: yellow;">■</span>	630
1189927 <span style="color: yellow;">■</span>	800
1189928 <span style="color: yellow;">■</span>	1000
1189929 <span style="color: yellow;">■</span>	1250

Tool group A26

Type 493 **Spindle holder**



Item no.	Size
1189933 <span style="color: yellow;">■</span>	160
1189934 <span style="color: yellow;">■</span>	200
1189935 <span style="color: yellow;">■</span>	250
1189936 <span style="color: yellow;">■</span>	315
1189937 <span style="color: yellow;">■</span>	400
1189938 <span style="color: yellow;">■</span>	500
1189939 <span style="color: yellow;">■</span>	630
1189940 <span style="color: yellow;">■</span>	800
1189941 <span style="color: yellow;">■</span>	1000
1189942 <span style="color: yellow;">■</span>	1250

Tool group A26

Type 493 **Safety key**



Item no.	Size
1189907 <span style="color: red;">▲</span>	160
1189908 <span style="color: red;">▲</span>	200
1189909 <span style="color: red;">▲</span>	250
1189910 <span style="color: red;">▲</span>	315
1189911 <span style="color: red;">▲</span>	400
1189912 <span style="color: red;">▲</span>	500
1189913 <span style="color: red;">▲</span>	630
1189914 <span style="color: red;">▲</span>	800
1189915 <span style="color: red;">▲</span>	1000
1189916 <span style="color: red;">▲</span>	1250

Tool group A26

Type 402 **Fixing screws for top jaws bolt 1**

Item no.	Size	Thread
1189907 <span style="color: yellow;">■</span>	200	3/8" - 16x30mm
1189908 <span style="color: yellow;">■</span>	250/315	1/2" - 13x40mm
1189909 <span style="color: yellow;">■</span>	400	5/8" - 11x45mm
1189910 <span style="color: yellow;">■</span>	500	3/4" - 10x55mm
1189911 <span style="color: yellow;">■</span>	630	3/4" - 10x60mm
1189912 <span style="color: yellow;">■</span>	800	3/4" - 10x65mm
1189913 <span style="color: yellow;">■</span>	1000/1250	3/4" - 10x45mm

Tool group A26

Type 402 **Fixing screws for top jaws bolt 2**

Item no.	Size	Thread
1189907 <span style="color: yellow;">■</span>	200	3/8" - 16x20mm
1189908 <span style="color: yellow;">■</span>	250/315	1/2" - 13x25mm
1189909 <span style="color: yellow;">■</span>	400	5/8" - 11x30mm
1189910 <span style="color: yellow;">■</span>	500/630/800	3/4" - 10x40mm
1189911 <span style="color: yellow;">■</span>	1000/1250	3/4" - 10x45mm



## Accessories UGE-UGU

Tool group A09  
Type 324 **short taper plate**  
ISO 702-1 (DIN 55026) for cylinder  
screw with mounting from front

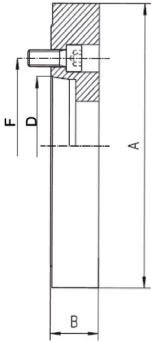

Item no.	Size	Taper	Ø A	B	D	F	Through-hole
1193011	200	5	203	40	82,575	104,8	40
1193012	200	6	203	43	106,39	133,4	55
1193013	250	5	203	40	82,575	104,8	40
1193014	250	6	203	43	106,39	133,4	55
1193015	250	8	203	50	139,735	171,4	79,5
1193016	315	5	253	40	82,757	104,8	40
1193017	315	6	253	43	106,39	133,4	55
1193018	315	8	253	50	139,735	171,4	79,5
1193019	400	6	318	43	106,39	133,4	55
1193020	400	8	318	55	139,735	171,4	79,5
1193021	400	11	318	65	196,885	235	103
1193022	500	6	405	43	106,39	133,4	55
1193023	500	8	405	49	139,735	171,4	79,5
1193024	500	11	405	75	196,885	235	103
1193025	630	8	405	49	139,735	171,4	79,5
1193026	630	11	405	75	196,885	235	103
1193027	630	15	405	75	285,8	330,2	103

finished on machine side, faced on chuck side, especially

Tool group A09  
Type 319 **Short-taper adapter  
plates**  
ISO 702-3 (DIN 55027) with studs  
and locknuts

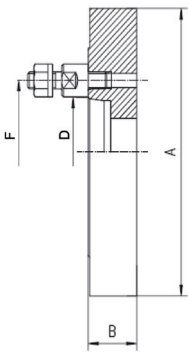

Item no.	Size	Taper	Ø A	B	D	F	Through-hole
1193028	200	5	203	38	82,575	104,8	61
1193029	200	6	203	38	106,39	133,4	61
1193030	250	5	253	33	82,575	104,8	79,5
1193031	250	6	253	50	106,39	133,4	79,5
1193032	250	8	253	46	139,735	171,4	79,5
1193033	315	5	253	33	82,575	104,8	79,5
1193034	315	6	253	50	106,39	133,4	79,5
1193035	315	8	253	46	139,735	171,4	79,5
1193036	400	6	318	38	106,39	133,4	103
1193037	400	8	318	55	139,735	171,4	103
1193038	400	11	318	47	196,885	235	103
1193039	500	6	405	38	106,39	133,4	103
1193040	500	8	405	43	139,735	171,4	103
1193041	500	11	405	47	196,885	235	103
1193042	630	8	405	43	139,735	171,4	103
1193043	630	11	405	47	196,885	235	103
1193044	630	15	405	50	285,8	330,2	103

finished on machine side, faced on chuck side, especially

Tool group A09  
Type 334 **Short-taper adapter  
plates**  
ISO 702-2 (DIN 55029) with studs  
for camlock

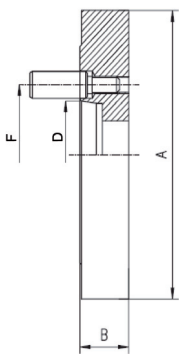

Item no.	Size	Taper	Ø A	B	D	F	Through-hole
1193045	200	4	203	44	63,525	85,6	61
1193046	200	5	203	50	82,575	104,8	61
1193047	200	6	203	42	106,39	133,4	61
1193048	250	4	253	35	63,525	82,1	61
1193049	250	5	203	49	82,575	104,8	79,5
1193050	250	6	253	49	106,39	133,4	79,5
1193051	250	8	253	49	139,735	171,4	79,5
1193052	315	6	253	49	106,39	133,4	79,5
1193053	315	8	253	49	139,735	171,4	79,5
1193054	400	6	318	70	106,39	133,4	103
1193055	400	8	318	55	139,735	171,4	103
1193056	400	11	318	55	196,885	235	103
1193057	500	8	405	55	139,735	171,4	103
1193058	500	11	405	55	196,885	235	103
1193059	630	8	405	55	139,735	171,4	103
1193060	630	11	405	55	196,885	235	103
1193061	630	15	405	60	330,2	235	103

finished on machine side, faced on chuck side, especially

# Chuck dimensions cast iron body

## Cylindrical centre mount

DIN 6350

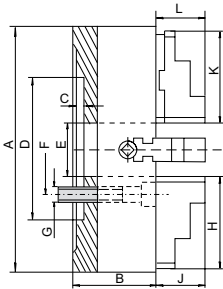

Size	160	200	250	315	400	500	630	800	1000	1250
A	160	200	250	315	400	500	630	800	1000	1250
B	65	75	85	95	105	120	140	135	150	165
C	5	6	7	7	10	12	12	12	15	15
D <sup>H7</sup>	65	75	150	175	200	270	270	250	320	400
E	45	56	65	80	100	125	160	210	260	305
F	95	95	104,8	133,4	171,4	235	235	300	370	500
G	4xM10	4xM10	4xM12	4xM16	4xM16	4xM20	4xM20	8xM20	8xM20	8xM20
H	61,5	85	96,5	111	129	152,5	177	202	240	240
J	31,5	35	40,3	49,8	49,8	59,8	59,8	70,8	91	91
L	-	46,4	60,4	60,9	72,3	90,3	97,8	93,8	119	119
K	-	82	96,5	112,5	129	136	136	136	160	160
approx. kg	7,5	10	25	39	61	105	163	319	370	700

## Short taper mount

DIN 55027 with studs and locknuts

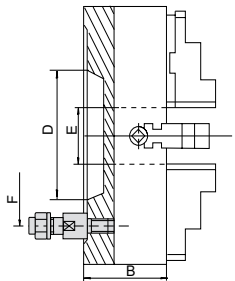

Size	200			250				315		
Taper size	4	5	6	4	5	6	8	5	6	8
B	75	75	75	85	85	85	85	95	95	95
D	63,5	82,5	106,3	63,5	82,5	106,3	139,7	82,5	106,3	139,7
E	56	56	56	60	65	65	65	80	80	80
F	85 <sup>1)</sup>	82,6	104,8	133,4	82,6	104,8	133,4	171,4	104,8	133,4
Mounting holes	DIN	3	4	4	-	4	4	4	4	4
	Camlock	3	6	6	3	6	6	6	6	6
approx. kg	10	10	10	27,5	27,5	27,5	27,5	39,5	39,5	39,5

DIN 55029 with studs for camlock

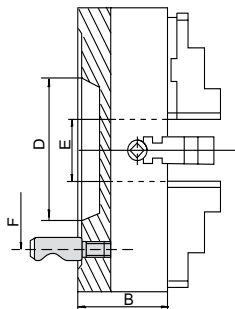

Size	400			500				630		
Taper size	6	8	11	6	8	11	8	11	15	
B	105	105	105	120	120	120	140	140	140	
D	106,3	139,7	196,8	106,3	139,7	196,8	139,7	196,8	285,7	
E	100	100	100	100	125	125	125	160	160	
F	133,4	171,4	235	133,4	171,4	235	171,4	235	330,2	
Mounting holes	DIN	4	6	4	4	6	4	6	6	
	Camlock	6	6	6	6	6	6	6	6	
approx. kg	60	60	60	95,5	95,5	95,5	165	165	165	

Size	800		1000			1250	
Taper size	11	15	11	15	11	15	
B	135	135	150	150	165	165	
D	196,8	285,7	196,8	285,7	196,8	285,7	
E	180	200	190	190	190	190	
F	235	330,2	235	330,2	235	330,2	
Mounting holes	DIN	6	6	6	6	6	
	Camlock	6	6	6	6	6	
approx. kg	298	298	370	370	700	700	

DIN 55026 mounting from front

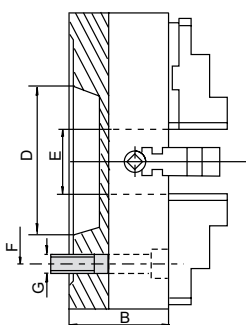

Size	200			250			315			400		
Taper size	5	6	5	6	8	5	6	8	6	8	11	
B	75	75	85	85	85	95	95	95	105	105	105	
D	82,5	106,3	82,5	106,3	139,7	82,5	106,3	139,7	106,3	139,7	196,8	
E	50	50	65	65	65	80	80	80	100	100	100	
F	104,8	133,4	104,8	133,4	171,4	104,8	133,4	171,4	133,4	171,4	235	
G	4xM10	4xM12	8xM10	4xM12	4xM16	4xM10	8xM12	4xM16	8xM12	4xM16	4xM20	
approx. kg	17	17	25,5	25,5	25,5	40	40	40	65	65	65	

Size	500			630			800			1000		1250	
Taper size	6	8	11	8	11	15	11	15	11	15	11	15	
B	120	120	120	140	140	140	135	135	150	150	165	165	
D	106,3	139,7	196,8	139,7	196,8	285,7	196,8	287,7	196,8	287,7	196,8	285,7	
E	100	125	125	125	160	160	180	180	180	190	190	190	
F	133,4	171,4	235	171,4	235	330,2	235	330,2	235	330,2	235	330,2	
G	4xM12	8xM16	8xM20	8xM16	8xM20	4xM24	8xM20	8xM24	8xM20	8xM24	8xM20	8xM24	
approx. kg	114	114	114	165	165	165	305	305	370	370	700	700	

# Jaw dimensions cast iron body

## Reversible one-piece jaw EB

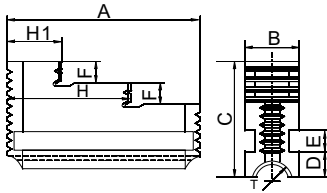

Size	160	200	250	315	400	500	630	800	1000	1250
A	61,5	85	92	111	129	152,5	177	202	245	245
B	20	27	27	40	40	52	52	70	80	80
C	51	61,5	61,	76,5	76,5	93,5	100,5	114,5	150	150
D	9	11,5	11,5	9,7	9,7	11,7	15,7	15,7	25	25
E	10	10	10	12	12	15	18	20	25	25
F	10	12	12	18	18	22	25	25	40	40
H1	20	30,5	30,5	27	32,5	35	45	44	65	65
H	41	58	65,5	67	78,5	93	109	122	160	160
Thread T	22x4	24x4	24x4	Tr32x6	Tr32x6	Tr36x6	Tr40x6	Tr44x8	Tr55x8	Tr55x8

## Base jaw GB

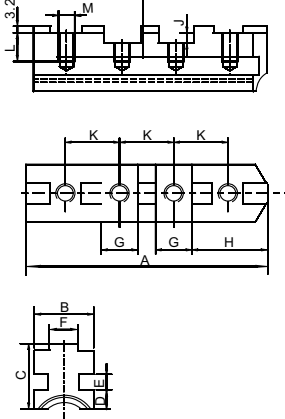

Size	200	250	315	400	500	630	800	1000	1250
A	79	94	110	129	168	206	206	305	305
B	27	27	40	40	52	52	70	80	80
C	32	38	39	44	59	59	59	76	76
D	11,5	11,5	9,7	9,7	11,7	15,7	15,7	25	25
E	10	10	12	12	15	18	20	25	25
F <sub>-0,03</sub>	7,94	12,7	12,7	12,7	12,7	12,7	12,7	12,7	12,7
G <sub>+0,01</sub>	12,69	19,04	19,04	19,04	19,04	19,04	19,04	19,04	19,04
H	33,2	37,5	45,4	54,9	55,5	55,5	55,5	57,74	57,74
J	4	4	4	7,2	7,2	7,2	7,2	7,2	7,2
K	22,25	27	31,75	38,1	38,1	38,1	38,1	38,1	38,1
L	14	20	17,5	22	33,5	33,5	33,5	35	35
M	3/8-16	1/2-13	1/2-13	5/8-11	3/4-10	3/4-10	3/4-10	3/4-10	3/4-10
Thread T	24x4	24x4	Tr32x6	Tr32x6	Tr36x6	Tr40x6	Tr44x8	Tr55x8	Tr55x8

## Unstepped soft top jaw AB

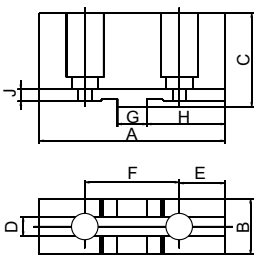

Size	200	250	315	400	500	630	800	1000	1250
A	90	106	120	140	145	145	145	170	170
B	40	47	52	52	60	60	80	85	85
C	43,5	51,5	55	64,5	82	82	85	102	102
D	7,95	12,71	12,71	12,71	12,71	12,71	12,71	12,71	12,71
E	24	27,5	30,7	34,4	34,4	34,4	34,4	46,4	46,4
F	44,5	54	63,5	76,2	76,2	76,2	76,2	76,2	76,2
G	12,69	19,04	19,04	19,04	19,04	19,04	19,04	19,04	19,04
H	40	45	53	63	63	63	63	75	75
J	4	4	4	4	4	4	4	4	4

## Reversible top jaw UB

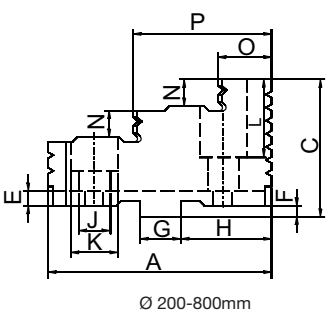

Size	200	250	315	400	500	630	800	1000	1250
A	82	96,5	112,5	129	136	136	136	160	160
B	34	34	42	42	54	54	72	82	82
C	43,5	51,5	55	64,5	74,5	82	88	102	102
D	7,95	12,71	12,71	12,71	12,71	12,71	12,71	12,71	12,71
E	4	4	4	4	4	4	4	4	4
F <sub>-0,03</sub>	3,2	3,2	3,2	6,3	6,3	6,3	6,3	6,3	6,3
G <sub>+0,01</sub>	12,69	19,04	19,04	19,04	19,04	19,04	19,04	19,04	19,04
H	35,2	40	47,9	57,4	58	58	58	70,48	70,48
J	11	14	14	18	22	22	22	22	22
K	18	20	20	26	33	33	33	33	33
L	21,5	26,5	27,5	32	39,5	43	46	71	71
M	3/8-16	1/2-13	1/2-13	5/8-11	3/4-10	3/4-10	3/4-10	3/4-10	3/4-10
N	9,5	12	13	13,5	18	21	24	57	57
O	22	25	27	26,5	37,5	37,5	40	80	80
P	53	62	70,5	79	87	87	89	-	-
R	19,3	22,5	25,7	28,8	29,4	29,4	29,4	41,82	41,82

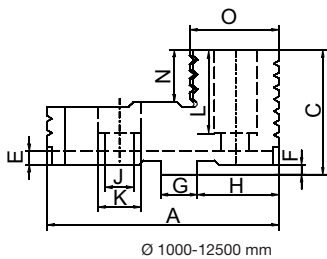

## Chucking capacities of jaw steps (standard values)

Size mm	160	200	250	315	400	500	630	800	1000	1250
A1 min.	8	10	10	15	20	45	50	50	170	170
A2 max.	160	200	250	315	400	500	630	800	1000	1250
max. swing. dia.	185	235	296	369	465	570	720	888	1088	1338

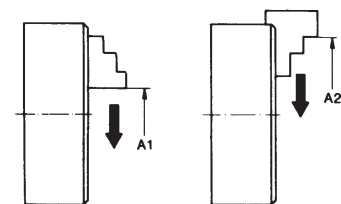

# Machine spindle noses for DIN and ASA B 5.9

Machine spindle noses are not included in the scope of delivery!

## DIN 800, with thread

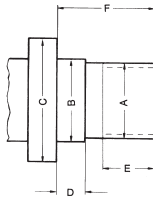
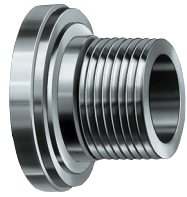

Mean tol. A	Bg5	Minimum C	D	E	F
M20	21	30	6,3	10	20
M24	25	36	8	12	24
M33	34	50	9	14	30
M39	40	56	10	16	35
M45	46	67	11	18	40
M52	55	80	12	20	45
M60	62	90	14	22	50
M76x6	78	112	16	30	63
M105x6	106	150	20	40	80

## DIN 55021

From taper size 4 with driver

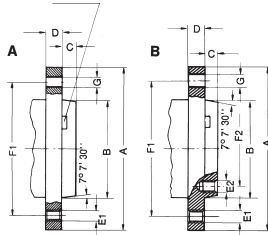

Spindle nose size					Holes on outer bolt circle (F1)		Outer bolt circle	Holes on inner bolt circle		Inner bolt circle
	A	B	C	D	E1	G	F1	(F2) E2	F2	
3	102	53,985	11	16	3xM10	3x10,5	75	-	-	
4	112	63,525	11	20	3xM10	3x10,5	85	-	-	
5	135	82,575	13	22	7xM10	4x10,5	104,8	8xM10	61,9	
6	170	106,390	14	25	7xM12	4x13	133,4	8xM12	82,6	
8	220	139,735	16	28	7xM16	4x17	171,4	8xM16	111,1	
11	290	196,885	18	35	12xM20	6x21	235	11xM20	165,1	
15	380	285,800	20	42	12xM24	6x25	330,2	11xM24	247,6	
20	520	412,800	21	48	12xM24	6x25	463,6	11xM24	368,3	

**Form A:** Tapped holes and through-holes in flange (without inner bolt circle)

**Form B:** Tapped holes and through-holes in flange (outer bolt circle) and tapped holes in inner bolt circle

## ISO 702-1 (DIN 55026)

From taper size 4 with driver

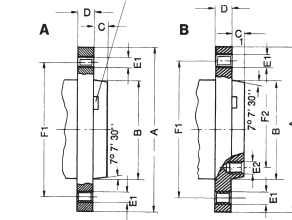

Spindle nose size					Holes on outer bolt circle		Outer bolt circle	Holes on inner bolt circle		Inner bolt circle
	A	B	C	C <sub>1</sub>	D	E1	F1	(F2) E2	F2	
3	92	53,983	11	-	16	3xM10	70,6	-	-	
4	108	63,521	11	-	20	11xM10	82,6	-	-	
5	133	82,573	13	14,288	22	11xM10	104,8	8xM10	61,9	
6	165	106,385	14	15,875	25	11xM12	133,4	8xM12	82,6	
8	210	139,731	16	17,462	28	11xM16	171,4	8xM16	111,1	
11	280	196,883	18	19,05	35	11xM20	235	8xM20	165,1	
15	380	285,791	19	20,638	42	12xM24	330,2	11xM24	247,6	
20	520	412,795	21	22,225	48	12xM24	463,6	11xM24	368,3	

**Form A:** Tapped holes in flange (outer bolt circle) without inner bolt circle.

**Form B:** Tapped holes in flange (outer bolt circle) and in inner bolt circle.

## ISO 702-3 (DIN 55027 und 55022)

With bayonet ring fixing (ISO 702/III)

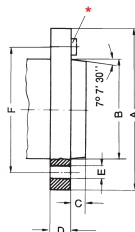

Spindle nose size	A	B	C	D	Number of holes x E	F
3	102	53,985	11	16	3x21	75
4	112	63,525	11	20	3x21	85
5	135	82,575	13	22	4x21	104,8
6	170	106,390	14	25	4x23	133,4
8	220	139,735	16	28	4x29	171,4
11	290	196,885	18	35	6x36	235
15	400	285,800	19	42	6x43	330,2
20	540	412,800	21	48	6x43	463,6

\* From taper size 4 with driver

# Machine spindle noses for DIN and ASA B 5.9

Machine spindle noses are not included in the scope of delivery!

ISO 702-2 (DIN 55029 and ASA B 5.9 D1)  
Camlock fixing (ISO 702-2)

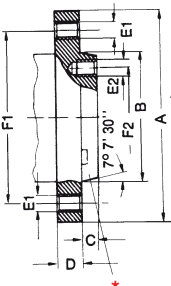
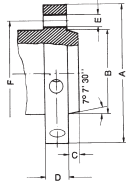

**A1:** Tapped holes in flange (outer bolt circle) and inner bolt circle. From taper size 4 with driver.

**A2:** Tapped holes in flange (outer bolt circle) without inner bolt circle.



**B1:** Through-holes in flange (outer bolt circle), tapped holes in inner bolt circle - from taper size 4 with driver.

**B2:** Through-holes in flange (outer bolt circle) without inner bolt circle.

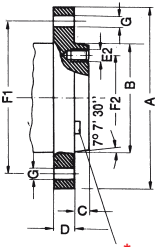

\* From taper size 4 with driver

Spindle nose size	A	B	C	D	E	F
3	92,1	53,985	11,1	31,8	3x15,1	70,66
4	117,5	63,525	11,1	33,3	3x16,7	82,55
5	146	82,575	12,7	38,1	6x19,8	104,8
6	181	106,390	14,3	44,5	6x23	133,4
8	225,4	139,735	15,9	50,8	6x26,2	171,4
11	298,5	196,885	17,5	60,3	6x31	235
15	403	285,800	19	69,9	6x35,7	330,2
20	546	412,800	21	82,5	6x42,1	463,6

Latest edition of relevant DIN standard applies in each case

Spindle nose size					Holes on outer bolt circle (F1)	Outer bolt circle	Holes on inner bolt circle (F2)	Inner bolt circle
	A	B	C <sub>-0,025</sub>	D	E1	F1	E2	F2

**A1 (corresponds ISO 702-1)**

5	133,4	82,575	14,288	22,2	11x 7/16-14 UNC	104,8	8x 7/16-14 UNC	61,9
6	165,1	106,390	15,875	25,4	11x 1/2-13 UNC	133,4	8x 1/2-13 UNC	82,6
8	209,5	139,735	17,462	28,6	11x 5/8-11 UNC	171,4	8x 5/8-11 UNC	111,1
11	279,4	196,885	19,05	34,9	11x 3/4-10 UNC	235	8x 3/4-10 UNC	165,1
15	381	285,800	20,638	41,3	12x 7/8-9 UNC	330,2	11x 7/8-9 UNC	247,6
20	520	412,800	22,225	47,6	12x 1-8 UNC	463,6	12x 1-8 UNC	368,3

Spindle nose size					Holes on outer bolt circle (F1)	Outer bolt circle
	A	B	C	D	E1	F1

**A2 (corresponds ISO 702-1)**

3	92,1	53,985	11,1	15,9	3x 7/16-14 UNC	70,66
4	108	63,525	11,1	19	11x 7/16-14 UNC	82,55
5	133,4	82,575	12,7	22,2	11x 7/16-14 UNC	104,8
6	165,1	106,390	14,3	25,4	11x 1/2-13 UNC	133,4
8	209,5	139,735	15,9	28,6	11x 5/8-11 UNC	171,4
11	279,4	196,885	17,5	34,9	11x 3/4-10 UNC	235
15	381	285,800	19	41,3	12x 7/8-9 UNC	330,2
20	520	412,800	20,6	47,6	12x 1-8 UNC	463,6

Spindle nose size					Outer bolt circle	Holes on inner bolt circle (F2)	Inner bolt circle
	A	B	C <sub>-0,025</sub>	D	F1 G	F1	E2

**B1**

5	133,4	82,575	14,288	22,2	11x11,9	104,8	8x 7/16-14 UNC	61,9
6	165,1	106,390	15,875	25,4	11x13,5	133,4	8x 1/2-13 UNC	82,6
8	209,5	139,735	17,462	28,6	11x16,7	171,4	8x 5/8-11 UNC	111,1
11	279,4	196,885	19,05	34,9	11x20,2	235	8x 3/4-10 UNC	165,1
15	381	285,800	20,638	41,3	12x23,4	330,2	11x 7/8-9 UNC	247,6
20	520	412,800	22,225	47,6	12x26,6	463,6	12x 1-8 UNC	368,3

Spindle nose size					Outer bolt circle	
	A	B	C	D	G	F1

**B2**

3	92,1	53,985	11,1	15,9	3x11,9	70,66
4	108	63,525	11,1	19	11x11,9	82,55
5	133,4	82,575	12,7	22,2	11x11,9	104,8
6	165,1	106,390	14,3	25,4	11x13,5	133,4
8	209,5	139,735	15,9	28,6	11x16,7	171,4
11	279,4	196,885	17,5	34,9	11x20,2	235
15	381	285,800	19	41,3	12x23,4	330,2
20	520	412,800	20,6	47,6	12x26,6	463,6



**MZMF**

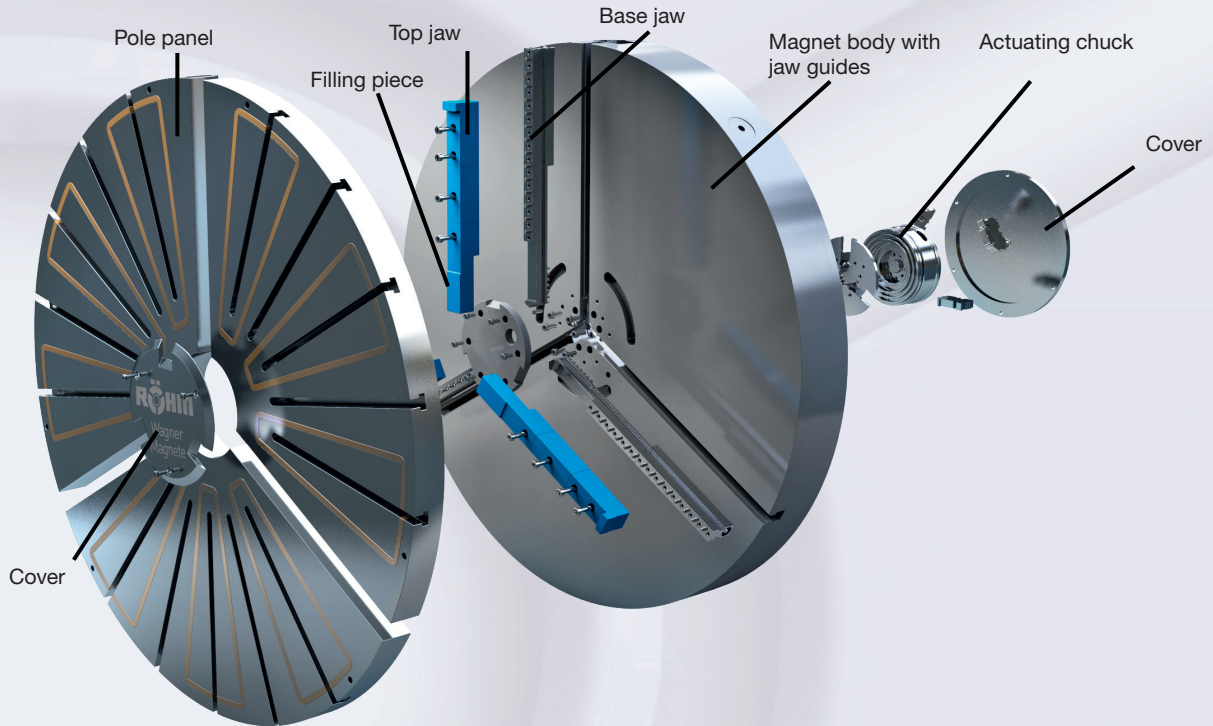

Hybrid chuck MZMF

**Maximum flexibility with minimum effort**

Fast, precisely centered and distortion-free chucking is of utmost importance, particularly with easily deformable work pieces, which require turning operation from all three sides within a working setup. This also applies to the precision machining of rings and other components that are difficult to grip, on which various turning and grinding operations must be performed.

The Hybrid Chuck MZMF by the technology partnership of RÖHM and Wagner Magnete is a combined 3-jaw self-centering chuck with a round magnetic clamping plate, which enables you to perform fast and highly flexible diverse operations. Along with the well known products from RÖHM, precisely centered chucking of workpieces result in trend-setting advantages for your machining process through the functions of the new technology.

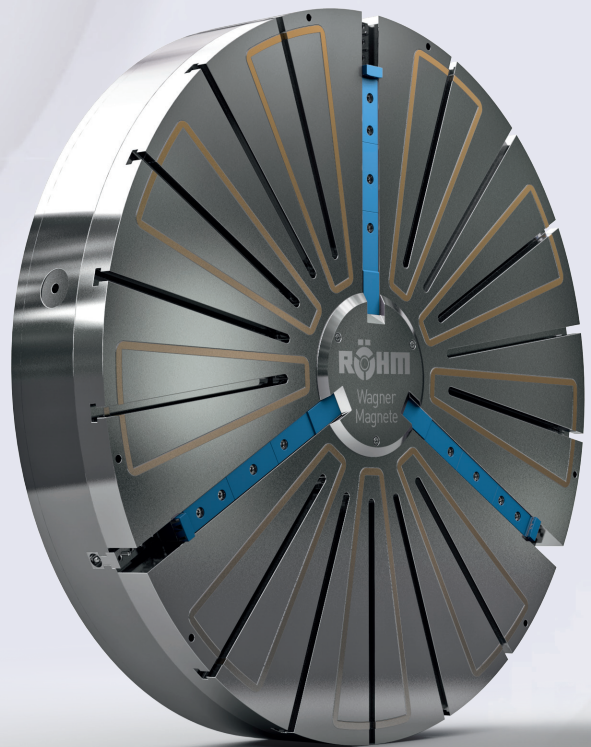

**Technische Merkmale:**

- Split second, precise gripping
- Reduced setup time of up to 50%
- Machine idle time is reduced to a minimum
- 3-side machining for turning and grinding components
- 16 individually adjustable steps of magnetic force
- Uniform and deformation free chucking
- Combined magnet and self-centering chuck clamping possible
- High processing safety for rational series production
- Quick amortisation
- Available in all sizes



## Overview

RÖHM provides an individual offer in special solutions for specific customer requests, which goes far beyond the standard programme. From the smallest “micro technology” chuck for the watches and jewellery industries to impressive chucks with over 5 meter diameters for rail vehicles or the energy sector.

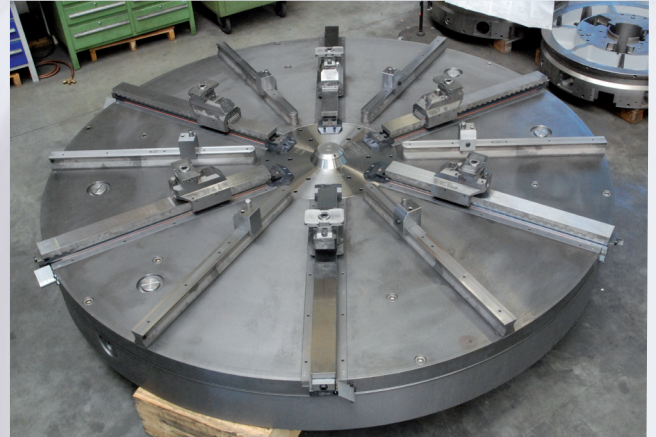

We develop special solutions in all shapes and sizes - for a wide variety of applications. Please contact us!

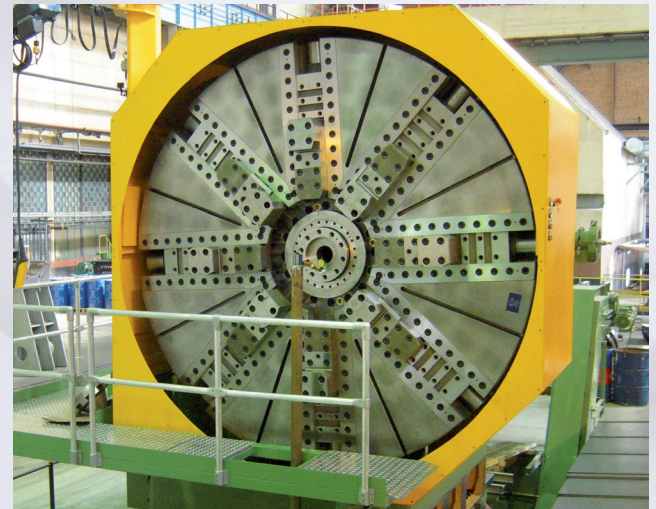

**Machining of Large Parts**  
Maximum precision, for maximum size



For further informations of our special solutions in any areas visit our homepage:

<http://www.roehm.biz/downloads/>



# The headquarter: our parent plant in Sontheim/Brenz.

The RÖHM parent plant is located in Sontheim/Brenz. In this ultra-modern production facility comprising 41,000 m<sup>2</sup>, optimum conditions have been achieved in order to solve the extensive range of discerning construction and production tasks making the company even better, faster and more efficient in the future.



Sontheim/Brenz



All national and international activities are planned and co-ordinated at the administrative headquarters in Sontheim. Thanks to the excellent infrastructure and transport routes available, this location is ideal for a company relying on perfect product quality as well as maximum flexibility. Furthermore, the region around Sontheim offers another key basis for the success of our company: it is rich in quality awareness and motivated employees with the result that we are ideally prepared for the challenges of the future. The parent plant uniquely unites mass production, serial production and customised individual production under a single roof.



# Key locations for the company: Dillingen and St. Georgen.

Such strong growth on the part of the RÖHM Group is also obviously associated with higher requirements on development and production capacities. The demands of today and tomorrow can be complied with the two facilities in Dillingen and St. Georgen.



Dillingen/Danube



St. Georgen

**Plant: Dillingen/Danube** | This branch plant in Dillingen was put into operation by the RÖHM Group as early as 1953. Thanks to extremely positive development, the plant is subject to constant expansion and modernisation. For this reason, new modern production facilities were built in 1982 and 1991. In 2007 RÖHM built a new production hall for two portal turning and milling machines. This enables machining of workpieces up to 4 metres in length which will secure a leading market position for the RÖHM brand in the future.

More than 300 employees are primarily involved in engineering and manufacturing lathe chucks, machine vices and special clamping equipment for turning and milling machinery as well as for machining centres.

**Engineering and sales department St. Georgen** | Apart from standard mandrels, tailor-made solutions for a wide variety of requirements are also manufactured here in this small but accomplished high-tech forge. RÖHM retains mechanical or power-operated mandrels, sliding jaw mandrels and hydraulic mandrels for its customers for tensioning workpieces in drill holes or interior contours.

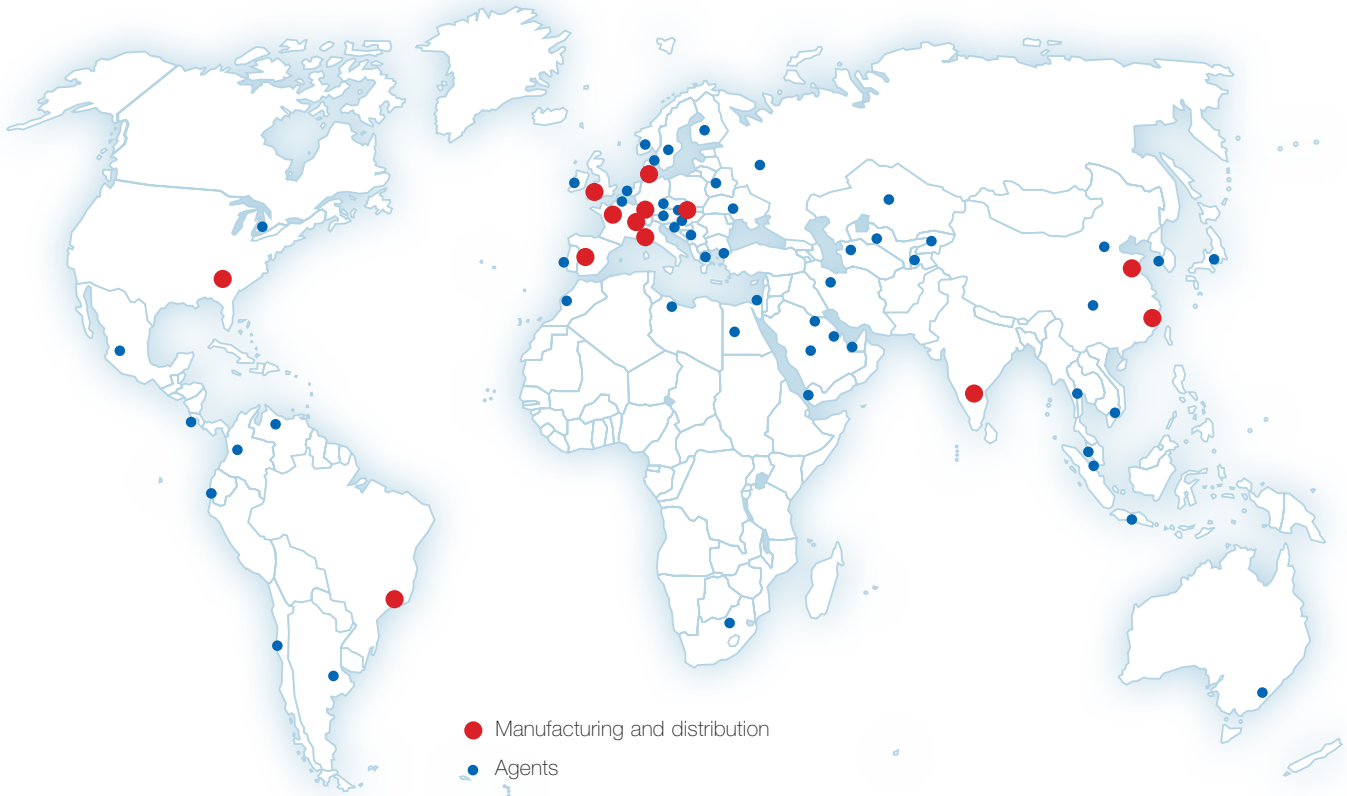

# Always close to our customers. With locations all around the world.

Customer orientation at RÖHM has less to do with marketing than with attitude. We consider customer proximity as an intensive dialogue with our partners as well as direct presence on key international markets.  
The RÖHM manufacturing and distribution bases:



RÖHM IND. E COM. DE FERRAMENTAS DE FIXAÇÃO LTDA.  
Brazil



ROEHM China Co., Ltd.  
China



RÖHM Værktojs A. S.  
Denmark



RÖHM S. A. R. L.  
France



ROHM (Great Britain) LTD.  
Great Britain



RÖHM SLOVAKIA S.R.O.  
Slovakia



ROHM INDIA PVT. LTD.  
India



RÖHM Italia S. R. L.  
Italy



RÖHM Spanntechnik AG  
Switzerland



RÖHM Iberica S. A.  
Spain



ROHM Products of America  
USA



# Your contacts at RÖHM.

## Manufacturing and distribution bases

### Germany:

#### **RÖHM GmbH**

Heinrich-Röhm-Straße 50  
89567 Sontheim/Brenz  
Tel 0049 73 25 – 16-0  
Fax 0049 73 25 – 16-510  
info@roehm.biz  
www.roehm.biz

#### **RÖHM GmbH**

Röhmstraße 6  
89407 Dillingen  
Tel 0049 90 71 – 5 08-0  
Fax 0049 90 71 – 5 08-174  
infodlg@roehm.biz

#### **RÖHM GmbH**

Feldbergstr. 5  
78112 St. Georgen  
Tel 0049 – 77 24 – 94 68 12  
Fax 0049 – 77 24 – 51 89  
Mobil 0171 – 7 63 67 35  
stg.info@roehm.biz

### Brazil:

#### **RÖHM IND. E COM. DE FERRAMENTAS DE FIXAÇÃO LTDA.**

Rod. Raposo Tavares, Km 14, s/nº  
Bloco A e C - Parte -Jardim Bandeirantes  
CEP 05576-900 - São Paulo  
Tel 0055 – 11 – 37 32 22 22  
Fax 0055 – 11 – 37 35 30 97  
vendas@rohm.com.br

### China:

#### **ROEHM China Co., Ltd.**

Room 401, Building 22,  
No. 518 Xinzhuan Road,  
Songjiang District  
201612 Shanghai  
Tel 0086 – 21 – 37 70 53 95  
Fax 0086 – 21 – 37 70 53 76  
roehmch@roehm.biz

#### **ROEHM WEIDA MACHINERY (Shandong) Co. Ltd. (Joint Venture)**

ADD: 2 Zhonghan Road  
Manshan Town Wendeng Shandong  
China 264414  
Tel 0086 – 631 – 8 54 99 86  
Fax 0086 – 631 – 8 54 50 18  
lts@weidapeacock.com

### Denmark:

#### **RÖHM Værktoj A.S.**

Gunnekær 2,  
2610 Rødovre  
Tel 0045 – 36 – 41 22 66  
Fax 0045 – 36 – 41 44 72  
info@roehm.dk

### France:

#### **RÖHM S.A.R.L.**

325, rue Paul Langevin  
60740 St. Maximin  
Tel 0033 – 344 64 10 00  
Fax 0033 – 344 64 00 68  
fr.roehm@roehm.biz  
www.rohm.fr

### Great Britain:

#### **ROHM (Great Britain) LTD.**

Unit 12 the ashway centre  
Elm crescent Kingston-upon-Thames  
Surrey KT 2 6 HH  
Tel 0044 – 20 85 49 66 47  
Fax 0044 – 20 85 41 17 83  
rohmg@roehm.biz  
www.uk.roehm.biz

### India:

#### **ROHM INDIA PVT. LTD.**

Plot No. A-53(B), Nallekandernahall  
Peenya 2nd Stage Industrial Area  
2nd Main Road  
560058 Bangalore India  
Tel 0091 – 80 – 41 49 29 07  
Fax 0091 – 80 – 28 36 76 56  
kthomas\_64@yahoo.com

### Italy:

#### **RÖHM Italia S.R.L.**

Via Brescia 24/C  
20063 Cernusco S. Naviglio  
Tel 0039 – 02 – 92 10 35 31  
Fax 0039 – 02 – 92 10 17 53  
rohmitalia@roehm.biz  
www.roehm-italia.it

### Slovakia:

#### **RÖHM Slovakia s.r.o.**

Partizanska 73  
95701 Banovce nad Bebravou  
Slovakia  
Tel 00421 – 3 87 60 02 22  
Fax 00421 – 3 87 60 02 24  
info@roehm.sk

### Spain + Portugal:

#### **RÖHM Iberica S.A.**

C/Rejas, No. 9 Nave 11 D  
28022 Madrid  
Tel 0034 – 91 – 3 13 57 90  
Fax 0034 – 91 – 3 13 57 93  
rohmitterica@roehm.biz  
www.roehm-iberica.es

### Switzerland:

#### **RÖHM Spanntechnik AG**

Feldstraße 39, 3360 Herzogenbuchsee  
Tel 0041 – 629 56 30 20  
Fax 0041 – 629 56 30 29  
roehmch@roehm-spanntechnik.ch  
www.ch.roehm.biz

### USA:

#### **ROHM Products of America**

5155 Sugarloaf Parkway, Suite K  
Lawrenceville, GA 30043  
Tel 001 – 770 – 963 - 8440  
Fax 001 – 770 – 963 - 8407  
rohmma@roehm.biz  
www.us.roehm.biz

Presence on all continents from  
A for Australia to V for Venezuela.  
You can receive the contact information  
of our worldwide representations easily  
through [www.roehm.biz](http://www.roehm.biz)

## Sales Agents in Germany

### Clamping technology - manual -

#### Baden-Württemberg:

Norbert Schrenk  
Tel. 0 71 21 / 5 14 76 05,  
Fax 0 71 21 / 5 14 76 06  
Mobil 0152 / 22 88 70 11  
E-mail: norbert.schrenk@roehm.biz

Werner Schmautz  
Tel. 0 78 02 / 98 27 51,  
Fax 0 78 02 / 7 00 94 27  
Mobil 0152 / 22 88 70 23  
E-mail: werner.schmautz@roehm.biz

#### Bayern (south):

Dieter Rabus  
Tel. 0 73 54 / 9 37 49 74,  
Fax 0 73 47 / 9 37 49 75  
Mobil 0152 / 22 88 70 24  
E-mail: dieter.rabus@roehm.biz

#### Bayern (north):

Gerhard Häutle  
Tel. 0 90 71 / 7 22 03  
Fax 0 90 71 / 7 22 03  
Mobil 0152 / 22 88 70 15  
E-mail: gerhard.haetle@roehm.biz

#### Hessen:

Joachim Nagel  
Tel. 0 60 45 / 98 39 00  
Fax 0 60 45 / 98 39 01  
Mobil 0171 / 6 20 91 59  
E-mail: joachim.nagel@roehm.biz

#### Niedersachsen:

Reiner Maahs  
Tel. 0 52 31 / 8 73 26  
Fax 0 52 31 / 8 73 26  
Mobil 0152 / 22 88 70 16  
E-mail: reiner.maahs@roehm.biz

#### Nordrhein-Westfalen:

Ralf Schnichels  
Tel. 0 21 61 / 9 99 72 43,  
Fax 0 21 61 / 9 99 72 47  
Mobil 0152 / 22 88 70 25  
E-mail: ralf.schnichels@roehm.biz

Thorsten Nolte  
Tel. 0 27 21 / 12 01 82  
Fax: 0 27 21 / 71 70 69  
Mobil 0152 / 22 88 70 31  
E-mail: thorsten.nolte@roehm.biz

#### Berlin, Mecklenburg-Vorpommern, Brandenburg, Sachsen-Anhalt:

Hendrik Seifert  
*please see - power operated -*

#### Sachsen, Sachsen-Anhalt,Thüringen:

Thomas Fischer  
*please see - power operated -*

#### Hamburg, Bremen, Schleswig-Holstein:

Michael Biß  
Tel. 0 431 / 3 97 09 59,  
Fax: 0 431 / 3 97 09 60  
Mobil 0152 / 22 88 70 27  
E-mail: michael.biss@roehm.biz

## Automation Technology

#### Germany / Europe

Robert Baß  
Tel. 0 73 22 / 91 13 37  
Fax 0 73 22 / 91 13 38  
Mobil 0152 / 22 88 70 33  
E-mail: robert.bass@roehm.biz

### Clamping technology - power operated -

#### Baden-Württemberg:

Michael Schmitz  
Tel. 00 33 / 388 72 04 03  
Fax 00 33 / 173 76 87 00  
Mobil 00 49 (0)152 / 22 88 70 18  
E-mail: michael.schmitz@roehm.biz

Michael Hartmann  
Tel. 0 90 73 / 91 41 6  
Fax 0 90 73 / 91 41 7  
Mobil 0152 / 22 88 70 28  
E-mail: michael.hartmann@roehm.biz

Frank Stier  
Tel. 0 74 26 / 91 37 70,  
Fax: 0 74 26 / 91 38 84  
Mobil 0152 / 22 88 70 19  
E-mail: frank.stier@roehm.biz

Richard Sedlak  
Tel. 0 70 21 / 94 98 97 0  
Fax: 0 70 21 / 94 90 72  
Mobil 0152 / 22 88 70 30  
E-Mail: richard.sedlak@roehm.biz

#### Bayern (south):

Dieter Baz  
Tel. 08649 / 98 63 75  
Fax: 08649 / 98 63 76  
Mobil 0152 / 22 88 70 26  
E-mail: dieter.baz@roehm.biz

#### Bayern (north):

Christian M. Merkel  
Tel. 0 91 61 / 66 41 39  
Fax 0 91 61 / 66 41 45  
Mobil 0152 / 22 88 70 14  
E-mail: christian.merkel@roehm.biz

#### Berlin, Mecklenburg-Vorpommern, Brandenburg, Sachsen-Anhalt:

Hendrik Seifert  
Tel. 0 30 / 70 07 24 59  
Fax 0 30 / 70 07 24 59  
Mobil 0152 / 22 88 70 32  
E-mail: hendrik.seifert@roehm.biz

#### Hessen:

Klaus Dieter Hofmann  
Tel. 0 64 06 / 90 67 40  
Fax 0 64 06 / 90 67 43  
Mobil 0152 / 22 88 70 29  
E-mail: k.d.hofmann@roehm.biz

#### Niedersachsen:

Reiner Maahs  
*please see - manual -*

#### Hamburg, Bremen, Schleswig-Holstein:

Michael Biß  
*please see - manual -*

#### Nordrhein-Westfalen:

Friedhelm Schneider  
Tel. 0 27 62 / 49 07 28  
Fax 0 27 62 / 49 07 29  
Mobil 0152 / 22 88 70 17  
E-mail: friedhelm.schneider@roehm.biz

Thorsten Nolte  
*please see - manual -*

#### Sachsen, Sachsen-Anhalt,Thüringen:

Thomas Fischer  
Tel. 0 37 41 / 52 13 56  
Fax 0 37 41 / 52 97 70  
Mobil 0152 / 22 88 70 10  
E-mail: thomas.fischer@roehm.biz

## Mandrel Technology

#### Germany

Thomas Haas  
Tel. 0 77 25 / 91 48 95  
Fax 0 77 25 / 91 48 96  
Mobil 0152 / 22 88 71 20  
E-mail: thomas.haas@roehm.biz

## Agents worldwide

#### Argentina:

Himaq S.R.L.,  
Venezuela 3652,  
1603 Villa Martelli  
Prov. Buenos Aires  
Tel. 00 541 / 147 093 505,  
Fax 00 541 / 147 093 472  
E-mail: himaq@himaq.com.ar

#### Australia:

White International Pty. Ltd.,  
PO Box 304 Milperra  
LPO NSW 2214  
Tel. 00 61 / 2 97 83 60 00  
Fax 00 61 / 2 97 83 60 01  
E-mail: sales@whiteint.com.au

#### Austria:

Richard Schörkhuber  
Lichtenhof 2 b  
8511 St. Stefan ob Stainz  
Tel. 00 43 / 34 63 / 8 15 10  
Fax 00 43 / 34 63 / 8 15 60  
Mobil 00 43 / 664 / 9 23 77 10  
E-mail: richard.schoerkhuber@roehm.biz

#### Schachermayer GmbH,

Schachermayer Str. 2  
Postfach 3000, 4021 Linz  
Tel. 00 43 / 732 / 65 99 - 0,  
Fax 00 43 / 732 / 65 99 14 44  
E-mail: maschinenmetall@schachermayer.at

#### Lackner u. Urnitsch GmbH

Bahnhofgürtel 37  
8020 Graz  
Tel. 00 43 / 316 / 71 14 80-0  
Fax 00 43 / 316 / 71 14 80 39  
E-mail: lackner@urnitsch.at

#### Haberkorn Ulmer GmbH

Hohe Brücke  
6961 Wolfurt  
Tel. 00 43 / 55 74 / 69 5-0  
Fax 00 43 / 55 74 / 69 5-99  
E-mail: info.wolfurt@haberkorn.com

#### Metzler GmbH u. Co. KG

Oberer Paspelsweg 6-8  
6830 Rankweil  
Tel. 00 43 / 55 22 / 7 79 63 - 0  
Fax 00 43 / 55 22 / 7 79 63 - 6  
E-mail: office@metzler.at

#### Belgium:

(Clamping technology - manual -)

#### BELTRACY

Bergensesteenweg 189  
1600 Sint-Pieters-Leeuw  
Tel. 00 32 / 25 43 68 90  
Fax 00 32 / 25 38 59 10  
E-mail: info@beltracy.be  
www.beltracy.be

(Clamping technology - power operated -)

#### ROHM S.A.R.L.

325, rue Paul Langevin  
60740 St. Maximin  
France  
Tel. 0033 / 344 64 10 00  
Fax. 0033 / 34 64 00 68  
E-mail: fr.roehm@roehm.biz  
www.rohm.fr

#### Bosnia-Herzegovina:

Kruhek d.o.o.,  
Veprinacka 16,  
10000 Zagreb (Kroatien)  
Tel. 00 38 / 513 695 138  
Fax 00 38 / 513 639 530  
E-mail: kruhek@zg.t-com.hr

#### Canada:

(Clamping technology - manual -)

#### Sowa Tool & Machine CO. LTD

500 Manitou drive  
N2G 4B6 Kitchener, Ontario  
Tel. 001 / 519 / 748 / 57 50  
Fax 001 / 519 / 748 / 93 04  
E-mail: sales@sowatool.com

(Clamping technology - power operated -)

#### ROHM Products of America

5155 Sugarloaf Parkway, Suite K  
Lawrenceville, GA 30043  
Tel. 001 / 770 / 963 / 8440  
Fax 001 / 770 / 963 / 8407  
E-mail: rohmusa@roehm.biz  
www.us.roehm.biz

#### Chile:

Robert Kralemann, SERVICOMP Ltda.  
Av. Departamental 1595  
La Florida - Santiago  
Tel. 00 56 / 2 / 8 89 47 00  
E-mail: rkralemann@gmail.com

#### Columbia:

Imocom S. A.  
Apartado Aereo 12287, Bogota D. E. 6  
Tel. 00 57-1 / 2 62 38 00  
Fax 00 57-1 / 2 62 49 82  
E-mail: imocom@imocom.com.co

#### Costa Rica:

Servicios Centroamericanos, S.A.  
625 Mts. Este del Parque de Tibás,  
frente a Autos LA FLORIDA, SAN JOSÉ,  
COSTA RICA  
P.O. Box : 4711-1000 SAN JOSE,  
COSTA RICA  
Tel. 00 506 / 2 40 11 11  
Fax 00 506 / 2 40 22 22  
E-mail: sercensa@sercensa.com

#### Croatia:

Kruhek d.o.o., Veprinacka 16  
10000 Zagreb (Croatia)  
Tel. 00 385 - / 0 / 1 - 36 95 - 138  
Fax 00 385 - / 0 / 1 - 36 39 - 530  
GSM: 00 385 - / 0 / 98 - 382 - 003  
E-mail: kruhek@zg.t-com.hr  
www.kruhek.hr

#### Czech Republic:

Jan Vysloulil  
Jiráskova 551  
76824 Hulín  
Tel. 00 420 / 5 73 35 18 00  
Fax 00 420 / 5 73 35 29 00  
E-mail: janvysloulil@iol.cz

#### Ecuador:

Maquinarias Henriques C.A.  
Casilla 4361, Via a Daule KM.6 1/2  
Guayaquil / Ecuador  
Tel. 00 593 - 4 / 2 25 43 00  
Fax 00 593 - 4 / 2 25 43 00 181  
E-mail: info@maquinarias-henriques.com

#### Finland:

Oy Interfii Ltd,  
Teollisuuskatu 35-39 LH4  
20520 Turku  
Y-tunnus 2374026-3  
Tel. 00 358 / 2 01 47 45 00  
Fax. 00 358 / 2 01 47 45 01  
Email: info@interfii.com

(Clamping technology - manual -)

#### Teräskonttori Oy,

Muuntotie 3,  
1510 Vantaa  
Tel. 00 358 / 9 61 54 71  
Fax 00 358 / 9 67 54 54  
E-mail: info@teraskonttori.fi

#### Greece:

Stefanos Papadopoulos,  
Kifisiasstr. 15,  
54655 Thessaloniki  
Tel. 00 30 / 23 10 48 87 58  
Fax 00 30 / 23 10 48 87 53  
E-mail: ST-papas@otenet.gr

#### Hungary:

Fairtool GmbH  
Kobanyai ut. 47/B  
H-1101 Budapest  
Tel. 00 361 / 8 14 46 21  
Fax 00 361 / 2 61 95 61  
E-mail: jozsef.alker@fairtool.hu

#### Indonesia:

GP System Singapur PTE LTD  
No. 51, Bukit Batok Crescent,  
#04-04/05 Unity Centre  
Singapore 658077  
Tel. 00 65 / 68 61 - 26 63, Fax: 35 00  
E-mail: enquiry@gpsystem.com

## Agents worldwide

### Iran:

Sakht Abzar Pars Co. (SAP)  
No. 19/4 Saeb Tabrizi St.,  
North Abbas Shirazi Ave.,  
Molla Sadra Ave.,  
Tehran post code 19917  
Tel. 00 98 / 21 / 88 03 18 88  
Fax 00 98 / 21 / 88 03 77 33  
E-mail: sales@sap-iran.com

### Ireland:

ROHM (Great Britain) LTD.  
Unit 12 the ashway centre  
Elm crescent Kingston-upon-Thames  
Surrey KT 2 6 HH  
Tel. 0044 - 20 85 49 66 47  
Fax. 0044 - 20 85 41 17 83  
rohmb@roehm.biz  
www.uk.roehm.biz

### Israel:

ETMOS Tool Distributing Co. Ltd.  
Industrial Zone, P.O. Box 1786,  
Holon 58117  
Tel. 00 972 - 3 / 55 81 933  
Fax 00 972 - 3 / 55 81 934  
E-mail: etmos@etmos.co.il

### Japan:

Takeda Trade Co., Ltd.  
Tokyo office  
113-0033, 3-5-2 Hongo  
Bunkyo-ku  
Tokyo / Japan  
Tel. 00 81/33815 6501  
Fax 00 81/33816 4522  
E-mail: hata@takeda-trade.co.jp

### Luxembourg:

ROHM S.A.R.L.,  
325 rue Paul Langevin  
60740 St. Maximin  
Tel. 00 33 / 3 44 64 10 00  
Fax 00 33 / 3 44 64 00 68  
E-mail: fr.roehm@roehm.biz

### Malaysia:

GP System Singapur PTE LTD  
No. 51, Bukit Batok Crescent,  
#04-04/05 Unity Centre  
Singapore 658077  
Tel. 00 65 68 61 - 26 63, Fax: 35 00  
E-mail: enquiry@gpsystem.com

### Marocco:

Somadu  
20-22, Bd. Abdellah Ben  
Yacine, Casablanca 20300  
Tel. 00 21 222/30 05 90, Fax 45 06 10  
E-mail: alaoui.my.youssef@somadu.com

### Macedonia:

G.T.M.Co. d.o.o.  
Export - Import  
Autoput Bg - Zg br. 22  
11080 Beograd  
Srbija i Crna Gora  
Tel. 00 381 / 1 13 14 90 24  
Fax 00 381 / 1 13 14 90 21  
E-mail: vladimir.rackovic@gtmco.rs

### Mexico:

Sales Power de Mexico S.A. DE C.V.  
Calle Jalpan No. 701  
76030 C.P. QUERETARO, QRO.-COL. EST  
Tel. 00 52 - 442 / 2 14 55 43  
Fax 00 52 - 442 / 2 24 01 12  
E-mail: salesfob@salespower-tools.com

### Netherlands:

(Clamping technology - manual -)  
Boorwerk B.V.,  
Flevolaan 52 A,  
Industrieterrian Noord  
1382 JZ Weesp  
Tel. 00 31 / 294 / 43 20 50  
Fax 00 31 / 294 / 43 21 52  
E-mail: info@boorwerk.nl

(Clamping technology - power operated -)

Friedhelm Schneider  
Tel. 0049 / 27 62 / 49 07 28  
Fax 0049 / 27 62 / 49 07 29  
E-mail: friedhelm.schneider@roehm.biz

### Norway:

Ing. Yngve Ege A/S  
Ryenstubben 5  
0679 Oslo 11  
Tel. 00 47 / 23 24 10 00  
Fax 00 47 / 23 24 10 01  
E-mail: ege@ege.no

### Poland:

ROHM GmbH  
Heinrich-Röhm-Straße 50  
89567 Sontheim/Brenz (Germany)  
Tel 0049 73 25 - 16-0  
Fax 0049 73 25 - 16-512  
info@roehm.biz

### Portugal:

ROHM Iberica S.A.  
C/Rejas, No. 9 Nave 11 D  
28022 Madrid  
Tel. 0034 / 91 / 3 13 57 90  
Fax 0034 / 91 / 3 13 57 93  
rohmliberica@roehm.biz  
www.rohm-iberica.es

### Russia:

ROHM GmbH  
Heinrich-Röhm-Straße 50  
89567 Sontheim/Brenz (Germany)  
Tel 0049 73 25 - 16-0  
Fax 0049 73 25 - 16-512  
info@roehm.biz

### OOO T.W.L. -Group

Kosmonavta Volkova 5, stroenie 1,  
127299 Moscow, Russia  
Tel. 007 / 495 / 5 04 72 39  
007 / 903 / 1 03 29 02  
Fax 007 / 495 / 6 18 42 68  
E-mail: sales@twl-group.ru

### Saudi-Arabia, VAE, Bahrain, Kuwait, Yemen, Libya, Egypt:

Dirk Jaegemann  
Trade agency GmbH & Co. KG  
Julius-Bamberger-Str. 1  
28279 Bremen  
Tel. 04 21 / 8 39 21 30  
Fax 04 21 / 8 39 89 21  
E-mail: info@djta.de

### Sweden:

Techpoint Systemteknik AB  
Nyponvaegen 4  
19144 Sollentuna  
Tel. 00 46 / 86 23 13 30  
Fax 00 46 / 86 23 13 45  
E-mail: info@techpoint.se

### Serbia-Montenegro:

G.T.M.Co. d.o.o.  
Export - Import  
Autoput Bg - Zg br. 22  
11080 Beograd  
Srbija i Crna Gora  
Tel. 00 381 / 1 13 14 90 24  
Fax 00 381 / 1 13 14 90 21  
E-mail: vladimir.rackovic@gtmco.rs

### Singapore:

GP System Singapur PTE LTD  
No. 51, Bukit Batok Crescent,  
#04-04/05 Unity Centre  
Singapore 658077  
Tel. 00 65 / 68 61 - 26 63,  
Fax 00 65 / 68 61 - 35 00  
E-mail: enquiry@gpsystem.com

### Slovenia:

Kruhek d.o.o., Veprinacka 16  
10000 Zagreb (Kroatien)  
Tel. 00 385 / 13 69 51 38  
Fax 00 385 / 13 63 95 30  
E-mail: kruhek@zg.t-com.hr

### Slovakia:

MCS s. r. o.  
Heckova 31  
SK - 97201 Bojnice  
Tel. 00 421 / 4 65 40 20 50  
Fax 00 421 / 4 65 40 20 48  
E-mail: michalovic@mcs.sk

### South Africa:

Kingstone Tools & Accessories  
P.O. Box 75746  
2047 Gardenview  
Tel. 00 27 / 11 / 6 22 16 68 / 9  
Fax 00 27 / 6 15 42 10  
E-mail: rohmtools@mweb.co.za

### South-Korea:

Cheong Do Trading Co., Ltd.  
RM-6-103, 604-1  
Kuro-Dong, Kuro-Ku, Seoul  
Tel. 00 822 / 6 78 41 55  
Fax 00 822 / 67 25 48 3  
E-mail: CDMT@chollian.net

### Taiwan:

V.T.M. Company Ltd.  
No. 13-1 11th Road,  
Taichung Industrial Park  
Taichung, TAIWAN  
Tel. 00 886 / 4 / 23 59 27 59  
Fax 00 886 / 4 / 23 50 74 27  
Email: luck@vtm.com.tw  
Email: lily@vtm.com.tw

### Thailand:

GP System Singapur PTE LTD  
No. 51, Bukit Batok Crescent,  
#04-04/05 Unity Centre  
Singapore 658077  
Tel. 00 65 / 68 61 / 26 63  
Fax 00 65 / 68 61 / 35 00  
E-mail: enquiry@gpsystem.com

### Turkey :

Sintek Mühendislik Makina San.  
Ve Tic. Ltd. Sti.  
Tarabya Mahallesi  
Yumak Sok. No: 3/A1  
34457 SARIYER - ISTANBUL  
Tel. 00 90 / 212 / 2 99 61 84  
Fax 00 90 / 212 / 2 99 56 75  
E-Mail: sinan.onurlu@sintekmuhendislik.com

### Ukraine:

T.W.L.-JUGA-Service  
41, Gradonochalnitzkaya str. 1  
65005 Odessa, Ukraine  
Tel. 00380 / 48 / 79 5 85 64  
Fax 00380 / 48 / 7 94 94 68  
E-mail: jugtech@twlweb.biz

### Venezuela:

Hartung Hnos. Sucr. C. A.,  
Apartado 2480  
Caracas 1010-A / Venezuela  
Tel. 00 58 / 212 / 54 20 820  
Fax 00 58 / 212 / 54 19 449  
E-mail: claus@hartung.com.ve

### Maquinaria Diekmann S.A.

AV. Humboldt - Las Acacias  
CARACAS 1040 / VENEZUELA  
Tel. 00 58 / 212 / 633 36 30 or  
Tel. 00 58 / 212 / 633 62 30  
Fax 00 58 / 212 / 633 22 62 or  
Fax 00 58 / 212 / 632 80 13  
E-Mail: purchase@diekmann.com.ve

### Vietnam:

CAP DO Industrial Equipment Co Ltd.,  
113/8A Tran Van Du Str.  
Ward 13, Tan Binh Dist.  
Ho-Chi-Minh-City  
Tel. 0084 / 8 / 38 10 45 33  
Fax. 0084 / 8 / 38 10 84 27  
E-Mail: capdo01@capdo.com.vn

# General conditions of sale and delivery

## § 1 Quotation, Formation of Contract and Content of Contract

1. The present General Terms of Sale and Delivery apply exclusively. We do not recognise any terms and conditions that are contradictory or different from our own, unless we have explicitly given our written agreement to do so. Our Terms of Sale and Delivery will also apply if we effect delivery to the Purchaser without any reservation in full awareness of the contradictory or different nature of the terms of the Purchaser, as compared to our own Terms.
2. Our quotations are always subject to change without notice unless they have been explicitly described as binding. The contract will only materialise upon our written confirmation and in line with the content thereof and by way of performance/delivery on our part. If delivery/service is immediately provided without any confirmation, the invoice will also be deemed to be the order confirmation.
3. Our General Terms of Sale and Delivery will only apply to a business entity as defined in Section 14 BGB [German Civil Code].
4. Costs for the compilation of drawings for specific constructions will be borne by the Orderer if, for reasons for which we are not responsible, the quotation does not lead to an order placement.
5. All particulars regarding weights, dimensions, services and technical data that feature in our printed matter, catalogues, price lists or in other contract documents are only approximate, unless they have been explicitly described as binding.
6. We retain the right to amend the construction and form of the subject of contract, providing this does not involve unreasonable alterations for the Orderer.
7. The documentation comprises an assembly layout, piece list with details of the wearing and spare parts, as well as operational and maintenance instructions; this is always in the German language. Documentation is only in paper form or in digital form. For digital forms, the texts are provided in the formats .TXT, .RTF or .DOC; drawings and piece lists are in the .TIF format (grid format). Any documentation in excess thereof will be billed and is subject to particular arrangement.
8. For testing, when specific temperatures, times and other measurements or control values are to apply, the appropriate measurement methods must be specified prior to delivery and acknowledged by both Parties. Unless such values are so defined, our own measurement methods will apply.
9. Samples will only be delivered subject to a fee.
10. Assurances given, ancillary agreements and changes to the contract will require the written form to be operative. It will not be possible to waive this requirement.
11. An order placement will be deemed irrevocable unless the Deliverer has agreed in writing to cancel it.
12. For export transactions, delivery will be subject to the conditions specified on the order confirmation; in addition, the respectively current version of the international trade definitions most commonly used in international sales contracts (incoterms 1953) will apply as devised by the International Chamber of Commerce.
13. In addition to the General Terms of Delivery and Sale, compliance with our "product information" sheets, the technical data sheets as well as other product-specific publications will apply, each in their current version.

## § 2 Prices

1. Failing specific written agreement, prices apply as in the Federal Republic of Germany, free house plus the value added tax required by law. For export transactions, the item to be delivered is deemed sold "ex works", unless the contract stipulates otherwise about the type of sale. For single orders for a value of goods less than 100.00 € net, a handling fee of 10.00 € plus the value added tax required by law will be charged throughout the country.
2. Please note that we only despatch the consignment at the request of the customer. Irrespective of this, the rulings laid down in Section 5 will apply.
3. We bill the prices that were valid when the contract was drawn up, based on the cost factors applicable at the time. Should these cost factors (particularly material, wages, energy etc.) alter during the period between the drawing up of contract and the agreed delivery time, we will be entitled to amend prices accordingly. For export transactions, the Deliverer will be entitled to cancel that part of the order that has not yet been completed or to adjust prices appropriately if the currency in which the contract was drawn up has devalued.
4. With an "ex works" contract, the goods will be transported at the expense and risk of the Orderer. For all consignments, the respectively current version of the provisions of incoterms 1953 will apply to the insurance and bearing of risk.
5. For parts/products that are produced in line with Purchaser requirements, we will notify the Purchaser of our production quantity. The Purchaser undertakes to take receipt of the quantity thus confirmed.
6. Over-deliveries and short-deliveries are admissible up to 5%; for special tooling up to 10% is admissible, at least, however, 2 (two) pieces. The respective delivery will be billed.

## § 3 Modalities of Payment

1. Failing specific arrangements, payment is due without deduction and without charges within 10 days of the date of invoice - even for delivery instalments.
2. We are not bound to accept cheques or bills. In the event cheques or bills are accepted subject to prior arrangement in individual circumstances, this will only be as conditional payment, taking due account of discount charges and collection fees that are to be paid immediately in cash by the Customer. The ultimate credit entry of bills of exchange and cheques will be after their redemption. The acceptance of cheques or bills will be without prejudice for subsequent commitments to payment. We will not be liable for the punctual presentation, protest, notification and return of a bill in the event it is not honoured.
3. Any overshooting of the payment deadline will incur interest to the amount of the banks' borrowing costs, at least, however 8% in excess of the respective basic interest rate of the European Central Bank.
4. If a bill or a cheque is not honoured on time or if a deadline for payment is over-reached, all receivables still outstanding, including those that are deferred and those for which bills or cheques have been given, will become due for immediate payment.
5. The Purchaser will only be entitled to offset if the counterclaims he asserts have been established by declaratory judgment, if they are undisputed or have been acknowledged by us. The Purchaser will be authorized to exercise a right of retention to the extent his counterclaim is derived from the same contractual relations.
6. For export transactions, payments will be paid subject to the modalities of payment contracted.

7. Costs of payment transactions, particularly bank charges of foreign payment transfers to us, are in principle for debits of the client.

## § 4 Delivery Period

1. The delivery period we specify begins to run providing all technical issues have been fully clarified. The delivery deadlines we give are in principle not binding and only constitute a probable delivery time.
2. The compliance with our commitment to deliver depends on the Purchaser having punctually and properly fulfilled his commitments, particularly his commitment to comply with the contracted terms of payment. The right to plea non-performance of contract will be retained. This right will also be derived from commitments that have not been satisfied in full from previous deliveries.
3. The period of delivery commences upon the despatch of the order confirmation, yet not before the Orderer has provided the documents, permits, clearance papers etc. to be procured and not before the agreed deposit has been received.
4. If a fixed delivery date has been arranged, the Deliverer will effect delivery on time. Compliance with the delivery period will be deemed given if the item to be delivered has left the works or the readiness for despatch has been notified before the expiry of said delivery period, subject to timely and accurate delivery from our own suppliers. If the Orderer amends parts of the consignment to be delivered, the delivery period will run anew upon confirmation of said amendment.
5. Force majeure, war, uprising, strike, lock-out or measures enforced by the authorities for whatever reason that impede delivery, as well as a lack of raw materials, means of transport and theft – even with our own suppliers – will release the Deliverer from his commitment to deliver within the specified period of time. The Orderer will be notified immediately of the occurrence of the hindrance and of the likely repercussions.
6. It is admissible to effect delivery prior to the expiry of the specified delivery period and to deliver in appropriate instalments.
7. Compliance with the delivery period depends on the fulfilment of all contractual duties of the Orderer.
8. In the event of delivery delays or of the impossibility of delivery, the provisions of Section 10 will apply.

## § 5 Transfer of Risk and Taking Receipt

1. Risk will pass to the Orderer at the latest with the despatch of the consignment, even if delivery is to be in instalments or if we still have other services to provide, e.g. despatch costs or transport and delivery as well as installation.
2. At the request and at the expense of the Orderer, we will ensure insurance cover of the consignment to be delivered for theft, breakage and damages from transportation, fire and water and for other insurable risks.
3. If despatch is delayed for reasons for which the Orderer is responsible, the risk will pass to the Orderer as from the date of readiness for despatch; nevertheless, we undertake to ensure insurance cover at the request and expense of the Orderer as called for by the Orderer.
4. Even if the delivered items feature insignificant defects, the Orderer will take receipt thereof irrespective of the rights laid down in Section 8.

## § 6 Default of Acceptance, Call-off Orders

1. If the Orderer fails to take receipt of the items contracted on time, we will be entitled to set the Orderer a subsequent period of grace after which we will be entitled to dispose of the items otherwise and supply the Orderer subject to a subsequently lengthened delivery period. Irrespective of this, we will be entitled to withdraw from the contract as defined in Section 326 BGB [German Civil Code] and to call for compensation for damages owing to non-performance. In the event we call for compensation for non-performance, we will be able to claim compensation of 25% of the agreed price plus value added tax without having to provide evidence. We retain the right to assert actual damages of a greater dimension.
2. Orders, which we confirm for call-off must be accepted within one year of the date of order placement at the latest - unless otherwise arranged. The same will apply to fixed reservations or to permanent "call-off" statuses. Section 6.1 will apply accordingly in the event the goods are not called off.

## § 7 Retention of Title

1. The items for delivery (the goods subject to the retention of title) will remain our property until all claims to which we are entitled from the Purchaser on the business relations have been satisfied in full. Where the value of all security interests to which we are entitled against the Purchaser exceeds all secured claims by more than 10%, we will release some of the security interests as appropriate at the request of the Purchaser.
2. During the period in which title to the goods is retained, the Purchaser is not allowed to pledge or assign the goods as security and is only permitted to resell to resellers in normal business transactions and only providing the reseller receives payment from its own customer or subjects the customer's ownership of the item to the full satisfaction of the customer's commitments to payment.
3. In the event of attachment, seizure or any other disposition or third-party intervention in respect of the goods, the Purchaser will notify us immediately so that we can file action subject to Section 771 ZPO [German Code of Civil Procedure]. If the third party is not able to reimburse us for the court and out-of-court costs of legal action pursuant to Section 771 ZPO, the Purchaser will be liable for the loss we thus incur.
4. The Purchaser undertakes to treat the item purchased with care. In particular, the Purchaser undertakes at his own expense to ensure it is adequately insured at reinstatement value against damages from fire, water and theft. Should maintenance and inspection work be required, the Purchaser will have this carried out in good time at his own expense.
5. In the event of breaches of duty on the part of the Purchaser, particularly with default in payment, we will be entitled to cancel the contract and to take back the goods; the Purchaser undertakes to surrender the goods. If we take back the goods and/or assert the retention of title, this does not mean we are cancelling the contract, unless we have explicitly declared as much.



# General conditions of sale and delivery

6. If the Purchaser has resold the item purchased in regular business transactions, the Purchaser herewith now assigns to us all claims to payment in the amount of the final invoice amount (including value added tax), such as due to the Purchaser from the resale to his customer or a third party, irrespective of whether the item purchased has been resold without or after further reworking. The Purchaser remains authorized to collect this payment, even after assignment. Our own authority to collect payment ourselves will not be affected hereby. However we undertake not to collect payment providing the Purchaser satisfies his own commitments to payment from the proceeds collected, does not default in payment and in particular providing the initiation of insolvency proceedings is not petitioned or payments cease to be made. Should this, however, be the case, we will be able to demand that the Purchaser provides us with details of the assigned payments and their debtors as well as all information necessary to collect payment, that he hands over the relevant documentation to us and notifies the debtors (third parties) of the assignment.

7. The processing or reworking of the item purchased by the Purchaser will always be carried out on our behalf. If the item purchased is processed with other items not belonging to us, we will acquire co-ownership to the new item to the value of the item purchased (final invoice amount including value added tax) in relation to the other processed items at the time of reworking. The same will apply to the thus newly created items as for the items delivered subject to retention of title.

8. If the item purchased is processed with other items not belonging to us, we will acquire co-ownership to the new item to the value of the item purchased (final invoice amount including value added tax) in relation to the other processed items at the time of reworking. If the intermixing is such that the Purchaser's item is to be deemed the main item, it is herewith agreed that the Purchaser will transfer co-ownership to us proportionately. The Purchaser will keep the property in which we hold exclusive ownership or co-ownership on our behalf.

## § 8 Quality Defects

We are liable for defects in quality as follows:

1. All parts or services will be remedied, at our discretion, free of charge or redelivered or provided again that are found to feature a quality defect during the statutory period of limitation - irrespective of service life - providing the origin thereof already existed at the time of the passing of risk.
2. Claims to quality defects will become statute-barred in 12 (twelve) months. The period of time commences with the passing of risk (Section 6).
3. The Purchaser will immediately file written objection to the quality defect with us.
4. In the event objections are filed, the Purchaser will be permitted to refrain from payment to an extent appropriate to the quality defects featured. The Purchaser will only be able to refrain from payment if an objection is asserted, the justification of which cannot be doubted. If the objection has been asserted unjustifiably, we will be entitled to call for the reimbursement of the expenses incurred by us.
5. Initially we will always be granted an opportunity to remedy a defect within an appropriate period of grace.
6. Should the remedy fail, the Purchaser – notwithstanding any claims to damages – will be able to cancel the contract or reduce remuneration. The Purchaser will only be able to call for the reimbursement of fruitless expenditure if the defect in question is attributable to our own wilful intent or gross carelessness for which we are responsible.
7. Claims to defects in quality are not given if the divergence from the agreed nature of the product is only minimal, if usability is only insignificantly impaired, in cases of natural depreciation or damages generated after passing of the risk as a result of faulty or negligent treatment, excessive exposure, unsuitable operating media or because of specific outer impact that was not to be expected given the contract, as well as in cases of non-reproducible software errors. If amendments or repair work is carried out improperly by the Purchaser or by third parties, there will be no claims to the defects resulting or the effects thereof. The same will apply to a lack of compliance with our instructions on handling and other instructions and if maintenance is not carried out properly.
8. Claims of the Purchaser to a refund of the expenses incurred for the purpose of remedy, such as costs of transport, travel, labour and materials will be ruled out, when such expenses increase because the item delivered was brought to a destination other than the Purchaser's branch premises, unless said relocation is in accordance with the intended use of the item.
9. Legal claims to recourse against us on the part of the Purchaser will only be given if the Purchaser has entered into no agreement with his customer in excess of those claims to defects regulated by the law.
10. Claims to compensation for damages will be governed by Section 9. Any farther-reaching claims to quality defects or others than those governed in this Section or in Section 9 will be ruled out.

## § 9 Industrial Property Rights and Copyrights, Defects of Title

Unless otherwise agreed, we undertake to only effect delivery free from proprietary rights and third party copyrights (referred to in the following as industrial property rights) in the country of the delivery destination. In the event a third party files justified claims against the Purchaser for a breach of industrial property rights derived from deliveries we effected that are being used as contracted, we will be liable towards the Purchaser for the period of time specified in Section 8.2 as follows:

1. At our discretion and at our own expense, we will either procure a licence for the deliveries in question, alter them so that there is no breach of industrial property rights or we will provide a substitute. Should this not prove possible at appropriate conditions, the Purchaser will be entitled to the rights of cancellation or reduction as laid down by the law. The Purchaser will only be able to call for the reimbursement of fruitless expenditure if we are to blame for wilful intent or gross negligence. Our commitment to provide compensation for damages is governed by Section 10.
2. The above commitments will only be given if the Purchaser has given us immediate, written notification of the claims asserted by the third party, does not recognise any breach of rights and if we retain the right to initiate defence measures and negotiate a settlement. If the Purchaser ceases to use the item delivered in order to reduce damages or for other good cause, the Purchaser undertakes to inform the third party that this discontinuation of use does not embody any acknowledgement of a breach of industrial property rights.
3. Claims of the Purchaser will be ruled out if the Purchaser is responsible for the breach of industrial property rights.
4. Any claims of the Purchaser will also be ruled out if the breach of industrial property

rights was derived from specific specifications of the Purchaser, from an application that we could not foresee or from the item delivered being altered by the Purchaser or used in combination with products that we have not delivered.

5. In the case of breaches of industrial property rights, the provisions of Sections 8.4, 8.5 and 8.9 will apply appropriately to the claims of the Purchaser governed by Section 13.

6. Any farther-reaching claims to defects of title of the Purchaser or claims other than those governed by the present Section 9 against us or our vicarious agents will be ruled out.

## § 10 Overall Liability

1. Claims of the Purchaser to compensation for damages – irrespective of the legal nature of the claim asserted – will be ruled out.
2. The exceptions are:
  - a) Damages due to the violation of major contractual duties (cardinal duties). However, in the case of simple negligence, liability for damages will be restricted to foreseeable, typically occurring damages.
  - b) Damages derived from injury to life and limb if we are responsibility for the breach of duty.
  - c) Damages attributable to wilfully intentional or negligent violations, said breach of duty on the part of our legal representatives or vicarious agents being of equal status to any breaches of duty on our part.
  - d) Claim to damages for impossibility or inability.
3. Any alteration of the onus of proof to the detriment of the Purchaser does not relate to the above provisions.
4. Liability subject to the Product Liability Act remains unaffected hereby.
5. Where liability for compensation is ruled out or restricted in our respect, this will also apply to the personal liability for damages of our employees, our trade representatives and our vicarious agents.

## § 11 Duties to Involvement of the Purchaser

1. The involvement of the Purchaser that has been agreed to explicitly or implicitly in the contract will be subject to no specific remuneration, unless otherwise explicitly agreed.
2. The Purchaser undertakes to inform us in good time of all facts, which indicate that stocks and products we have made available in the light of our notified production capacities cannot be used or not be used in full. Where stock remains, in the case of a premature change to his planning, the Purchaser will take over the remainder and any costs of destruction that might be incurred. This will also apply to products for which we have had to place orders for minimum quantities from our own suppliers, providing we previously advised the customer thereof.
3. The Purchaser guarantees that the products delivered by him for reworking are suitable for the purpose. We do not undertake to check the products delivered by the Purchaser for their quality and aptitude for reworking. In ongoing business relations and whenever an item for reworking has been initially checked, tested and released, the Purchaser undertakes to inform us in writing of each and every product amendment without actually being requested to do so. When items are being reworked, after every change in production conditions on his premises, in particularly when substituting tooling, machinery or introducing new production processes, the Purchaser also undertakes to examine the item to be processed by us for any divergence and alteration and to notify us in writing of any such divergence and alteration.
4. Instructions from our Purchaser, the selection of material or other specifications laid down by the Purchaser do not oblige us to check them for accuracy.
5. The Purchaser will hence check all instructions it issues as well as the quality of the material specified to us or made available to us for compliance with the law and technical regulations.
6. Should the Purchaser default in terms of its duties to provide or to become involved, we will be entitled to the rights stipulated by law.
7. In any case, goods may only be returned subject to the explicit consent of the Deliverer. Their return will be free-house and details of the order number and delivery date will be given as well as the original delivery packaging. The goods will be in their original condition, i.e. in an undamaged state. For the handling of a return, we charge 20% of the value of the goods, at least, however, 50.00 € plus value added tax. In individual circumstances, the Deliverer retains the right to charge the Orderer a higher sum based on evidence.

## § 12 Place of Performance and Jurisdiction/ Other

1. The place of performance and payment will be the registered office of our company in Sontheim/Brenz.
2. Exclusively the laws of the Federal Republic of Germany will govern the present contractual relations. The application of the United Nations Convention dated 11.04.80 on Contracts for the International Sale of Goods (CISG – "Wiener Kaufrecht") is ruled out.
3. For all disputes derived from contractual relations, if the Orderer is a registered businessperson, a legal entity under public law or a separate estate under public law, legal action will be filed with the court of law with jurisdiction for our registered office. We will also be entitled to file legal action at the location of the registered seat of the Orderer.
4. Should any one condition of our General Terms of Sale and Delivery be void for any reason whatsoever, the validity of the remaining provisions will not be affected hereby.
5. We will save your data in accordance with Section 23 BDSG [Federal Data Protection Act].

ROHM GmbH

D-89565 Sontheim/Brenz

Revised: September 2012





” RÖHM – we’re here to serve you.



**We offer real partnership.**

We see this reflected in collaborative partnerships both with specialist dealers as well as directly with consumers. We offer sound advice, provide comprehensive support and do our utmost for you, so that you get exactly the right solution for meeting your targets safely and economically. And if there isn't a solution available yet, then we'll design it.





**RÖHM GmbH**

Heinrich-Röhm-Straße 50 | 89567 Sontheim/Brenz | Germany

Tel 0049 73 25 - 16-0 | Fax 0049 73 25 - 16-510

[info@roehm.biz](mailto:info@roehm.biz) | [www.roehm.biz](http://www.roehm.biz)